

B2/2

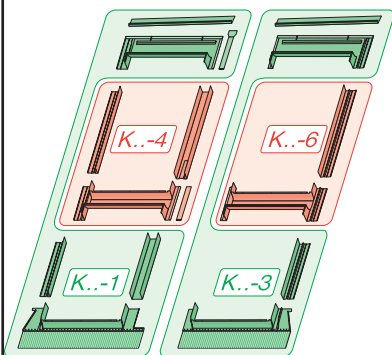

B3/2

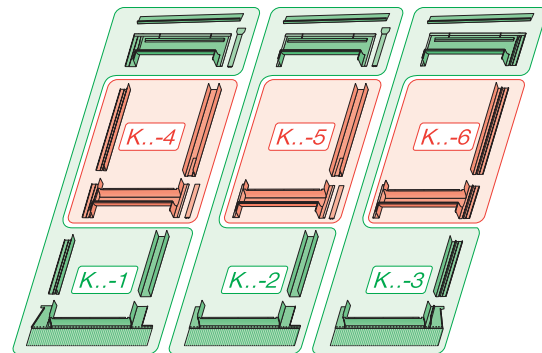

B4/2

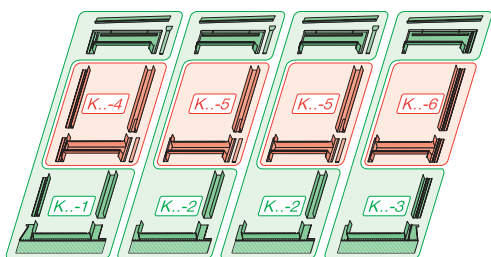

B2/3

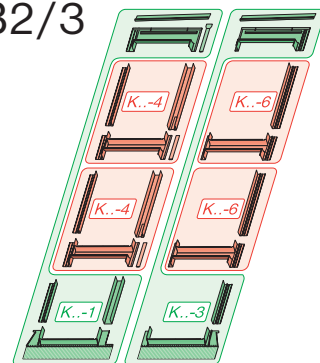

B3/3

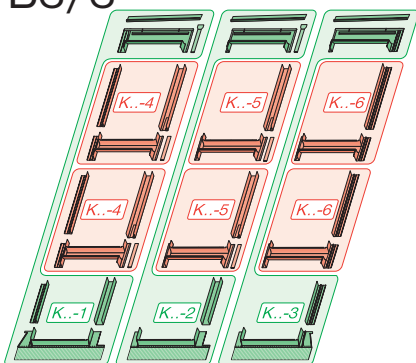

B4/3

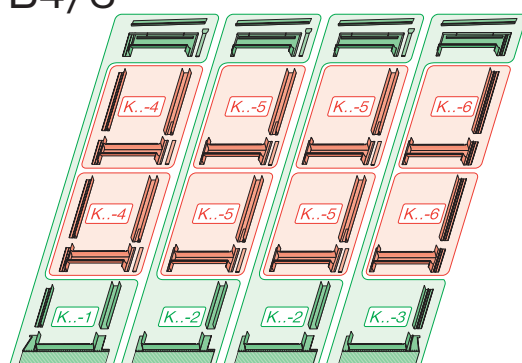

B 3/2

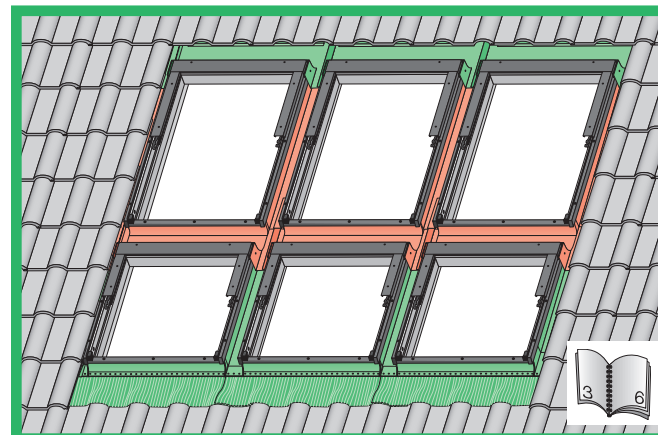

KHN+KXN
KHV+KXV

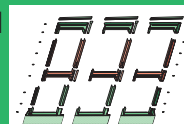

max 90mm

KZN+KXN
KZV+KXV
KZJ+KXJ

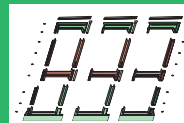

max 45mm

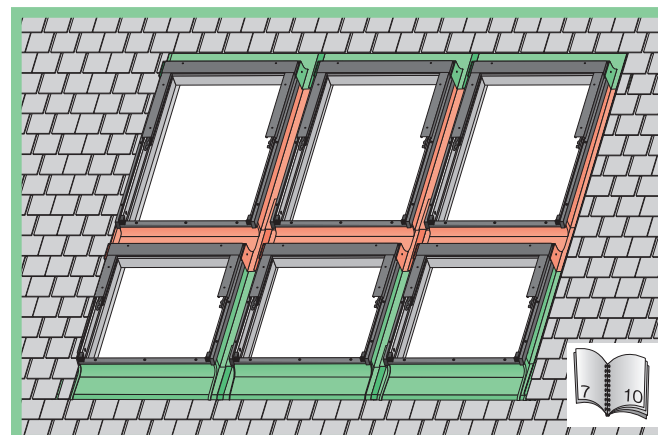

KSN+KXN
KSV+KXV
KSJ+KXJ

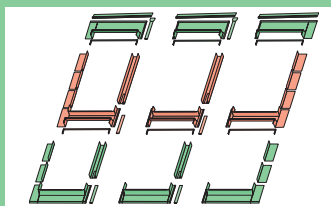

max 5mm

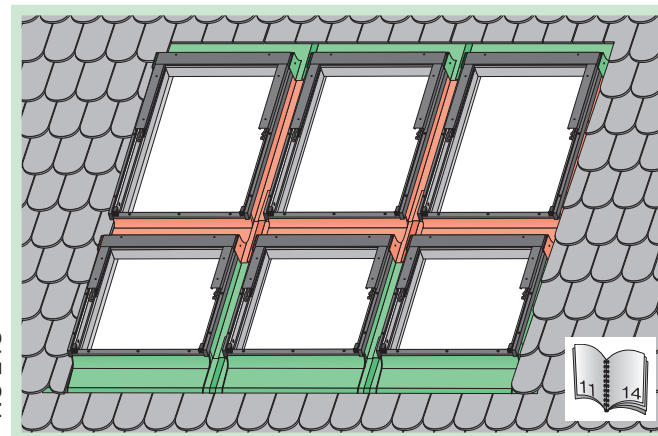

KLN₍₁₋₃₎+KLN₍₄₋₆₎
KLV₍₁₋₃₎+KLV₍₄₋₆₎
KLJ₍₁₋₃₎+KLJ₍₄₋₆₎

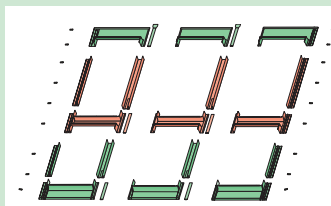

max 15mm (N)
max 5mm (V)
max 5mm (J)

NC 248

<p>max 90mm</p>	KHN-1+KHN-2+KHN-3+ KXN-4+KXN-5+KXN-6		
	KHV-1+KHV-2+KHV-3+ KXV-4+KXV-5+KXV-6		
	-	-	-

<p>max 45mm</p>	KZN-1+KZN-2+KZN-3+ KXN-4+KXN-5+KXN-6		
	KZV-1+KZV-2+KZV-3+ KXV-4+KXV-5+KXV-6		
	KZJ-1+KZJ-2+KZJ-3+ KXJ-4+KXJ-5+KXJ-6		

<p>max 5mm</p>	KSN-1+KSN-2+KSN-3+ KXN-4+KXN-5+KXN-6		
	KSV-1+KSV-2+KSV-3+ KXV-4+KXV-5+KXV-6		
	KSJ-1+KSJ-2+KSJ-3+ KXJ-4+KXJ-5+KXJ-6		

<p>max 15mm (N) max 5mm (V) max 5mm (J)</p>	KLN-1+KLN-2+KLN-3+ KLN-4+KLN-5+KLN-6		
	KLV-1+KLV-2+KLV-3+ KLV-4+KLV-5+KLV-6		
	KLJ-1+KLJ-2+KLJ-3+ KLJ-4+KLJ-5+KLJ-6		

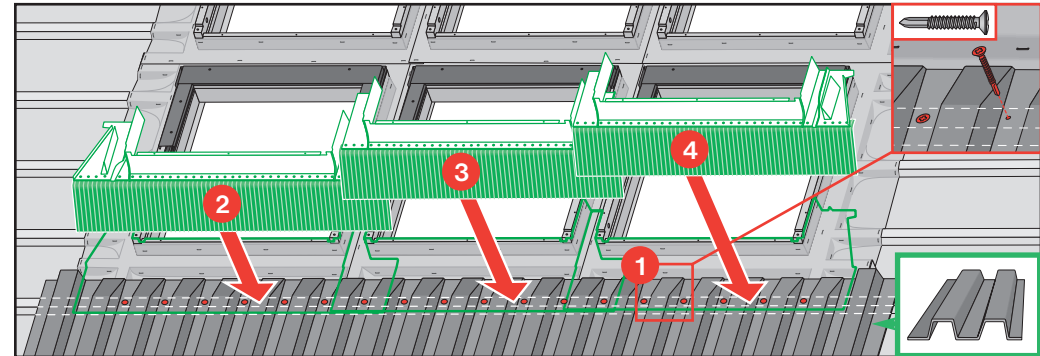
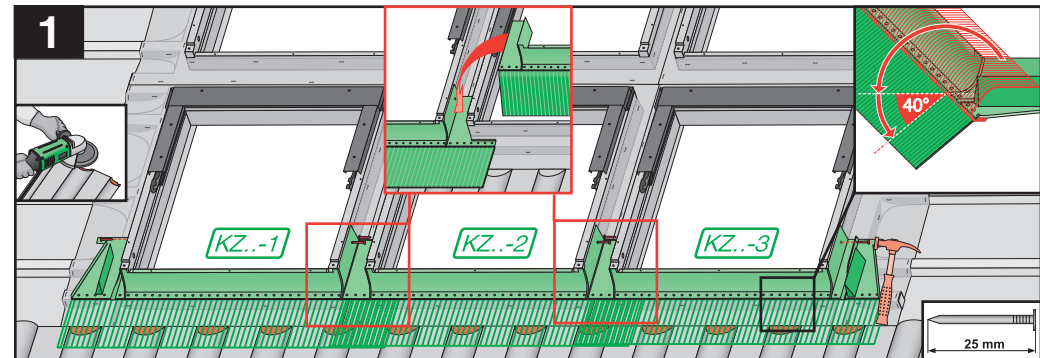
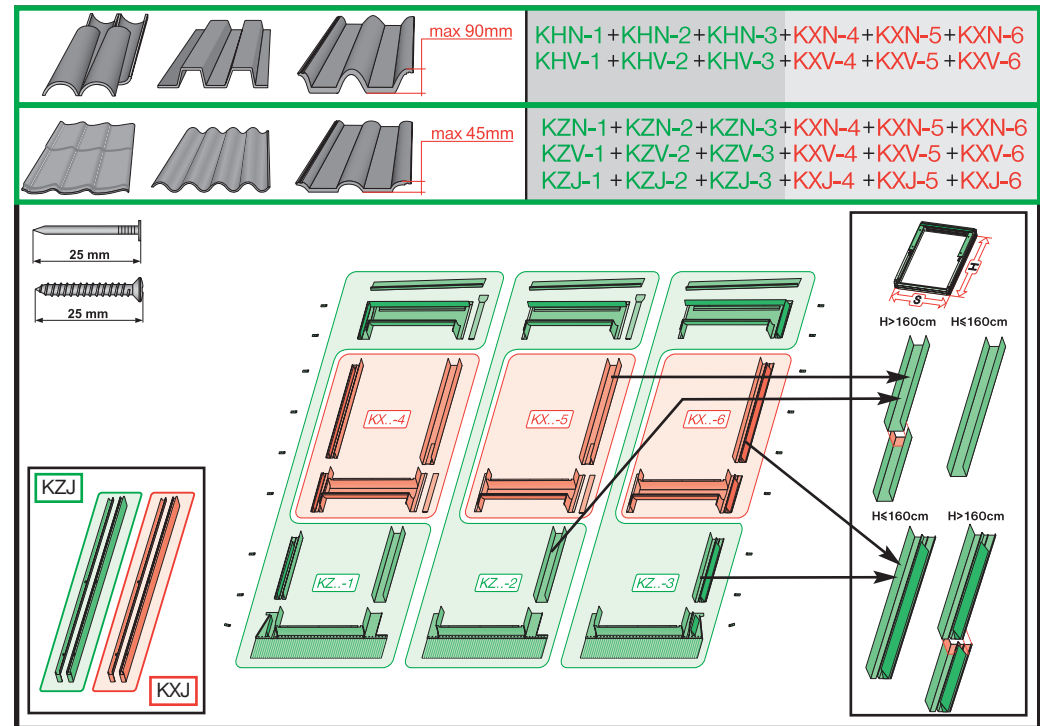

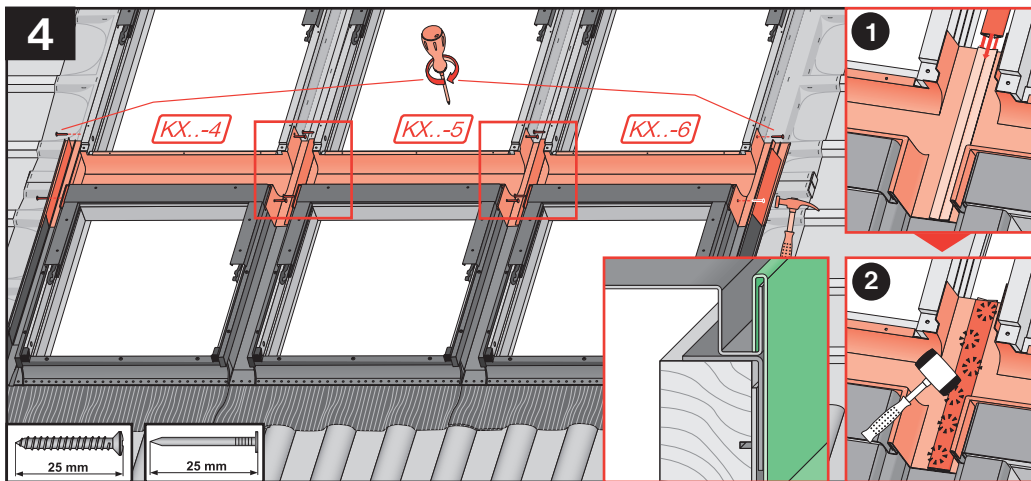
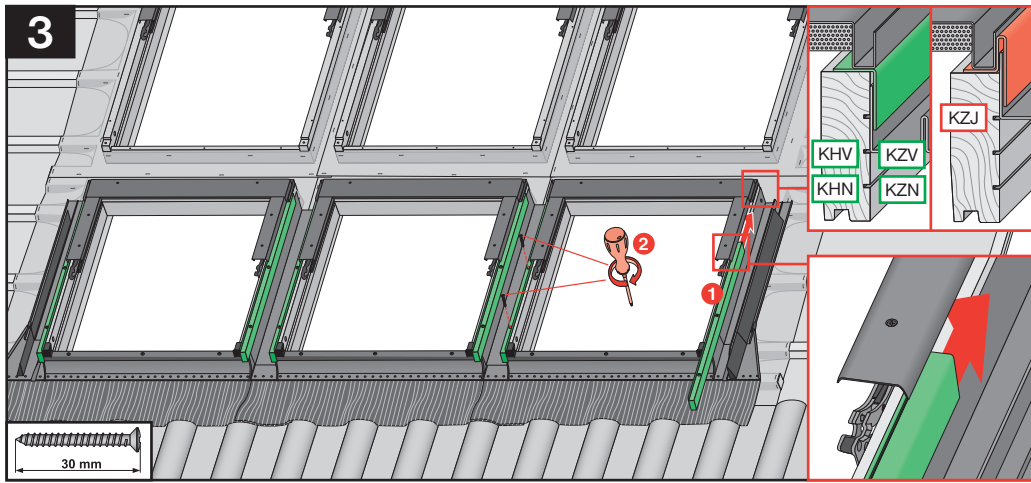
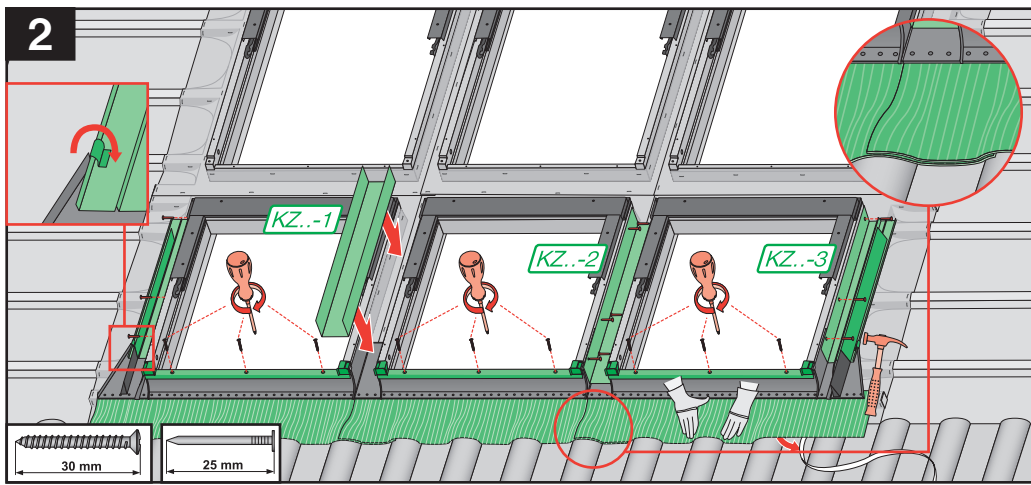

4

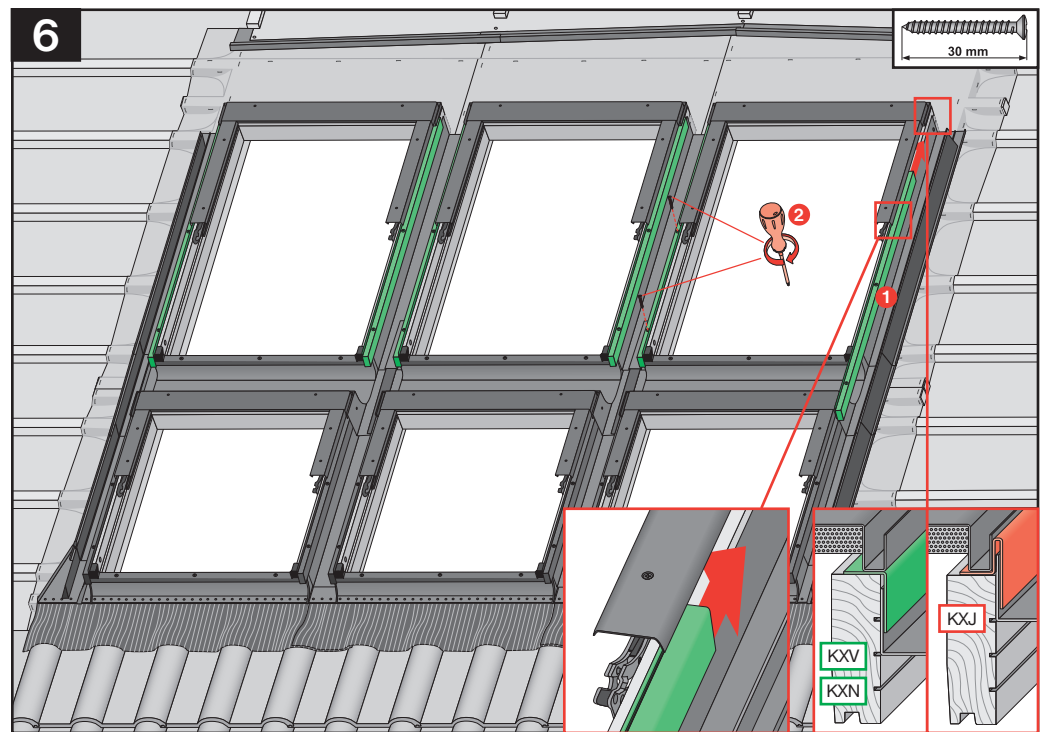
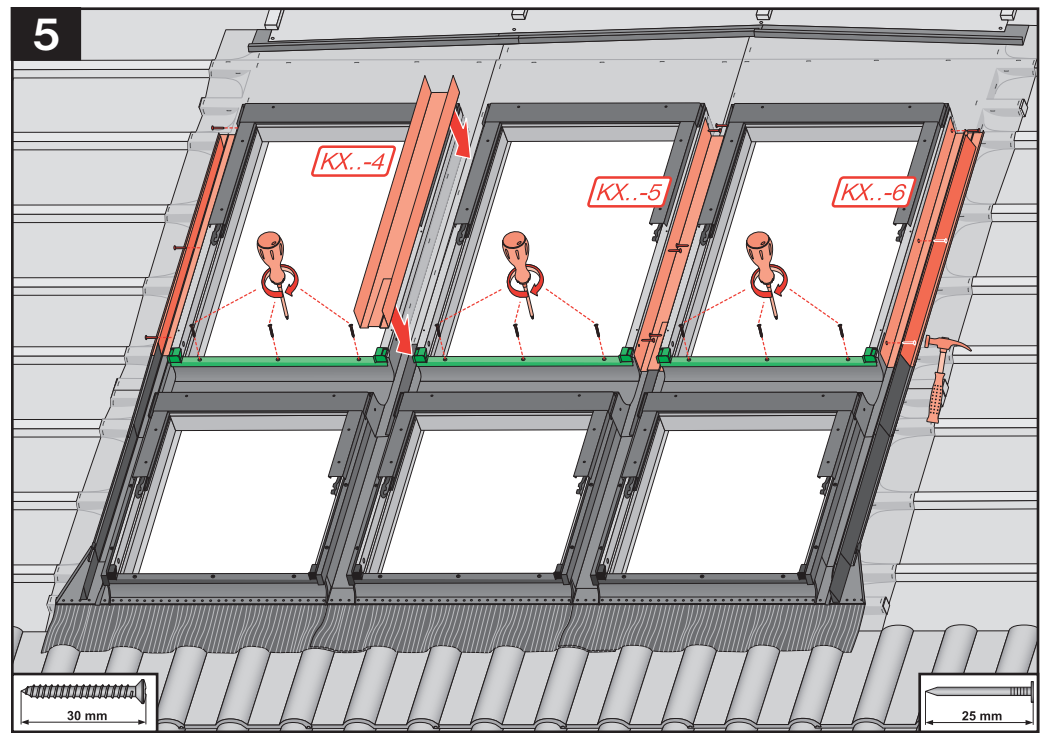

5

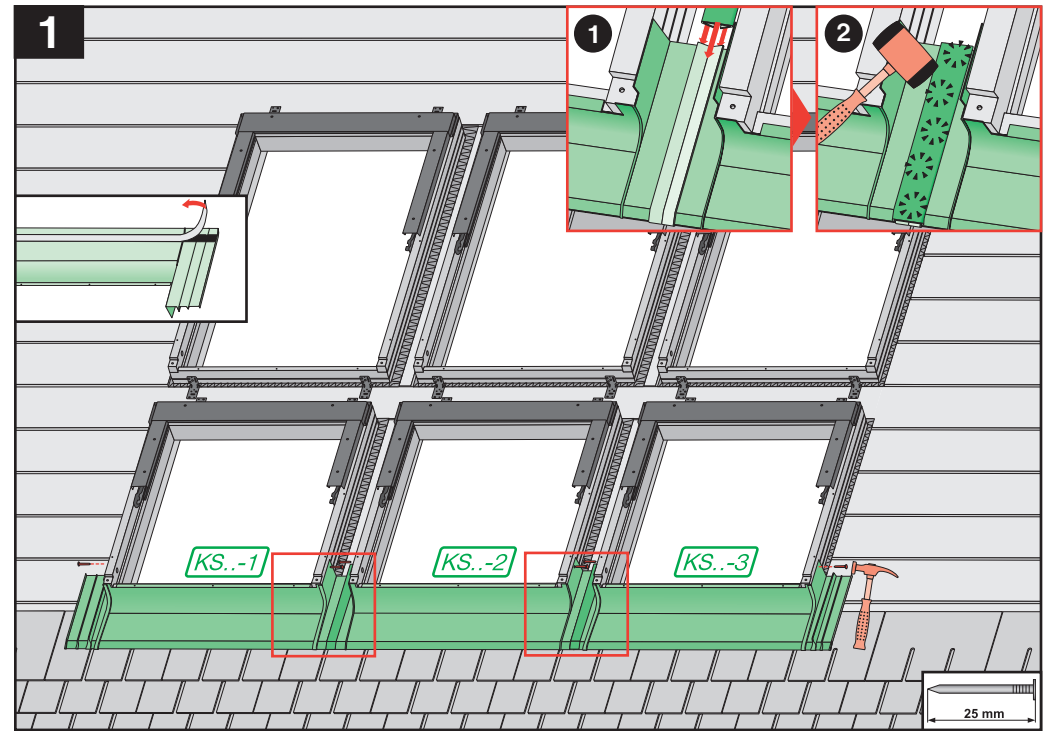
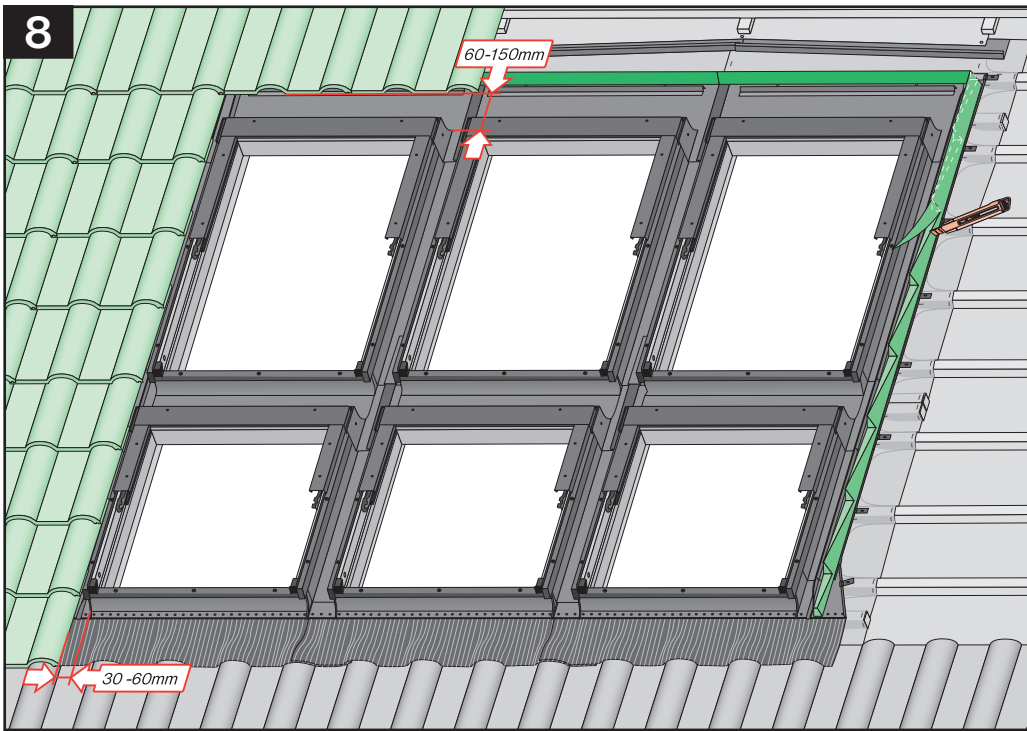
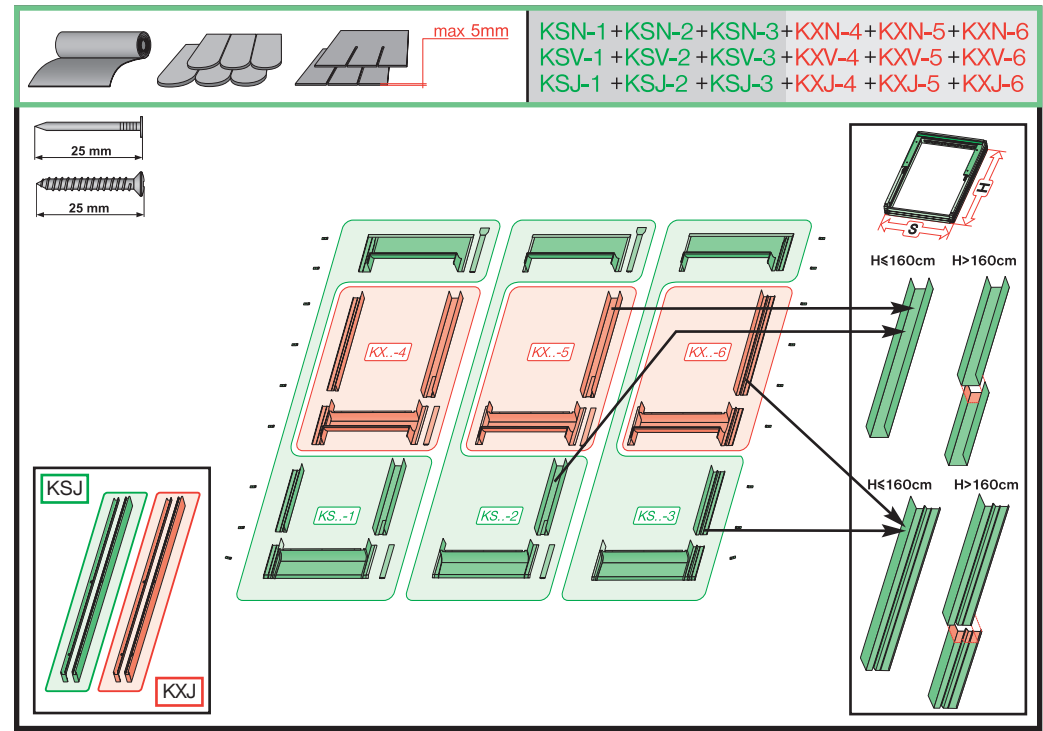
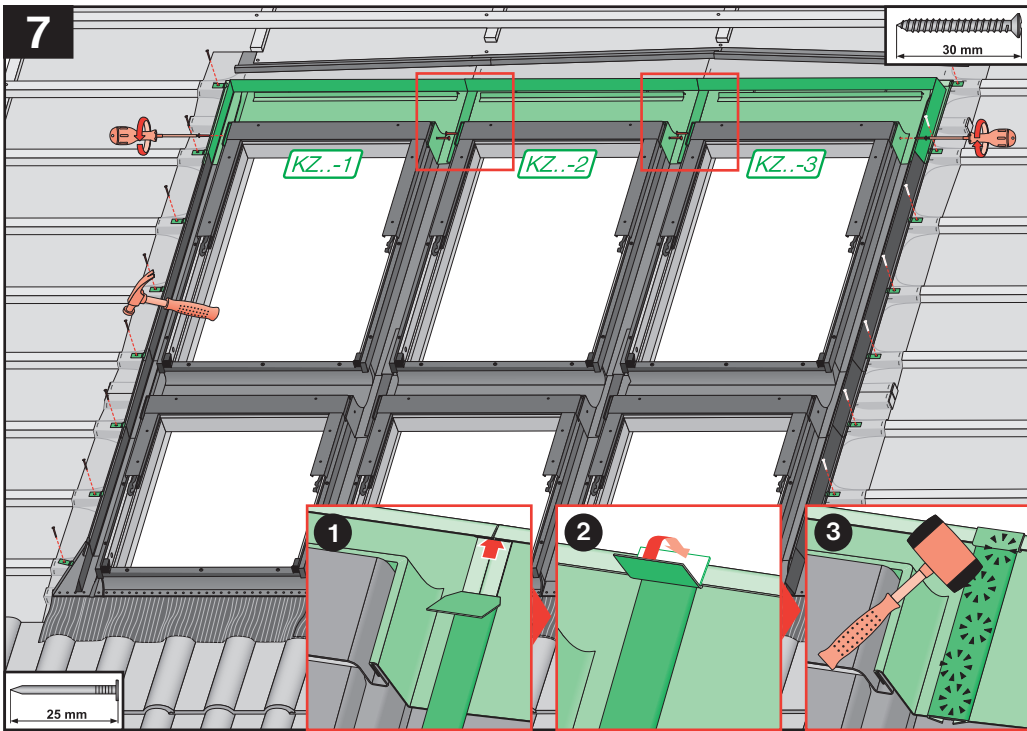

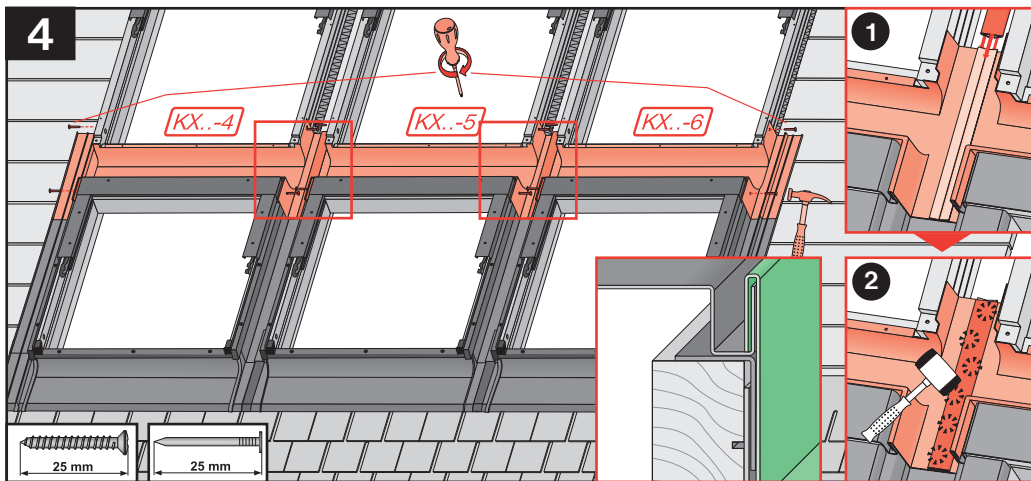
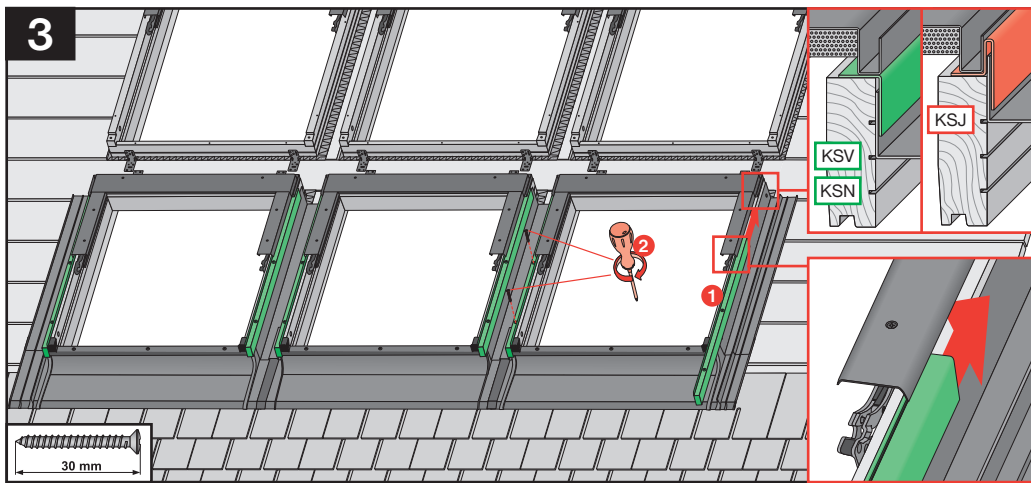
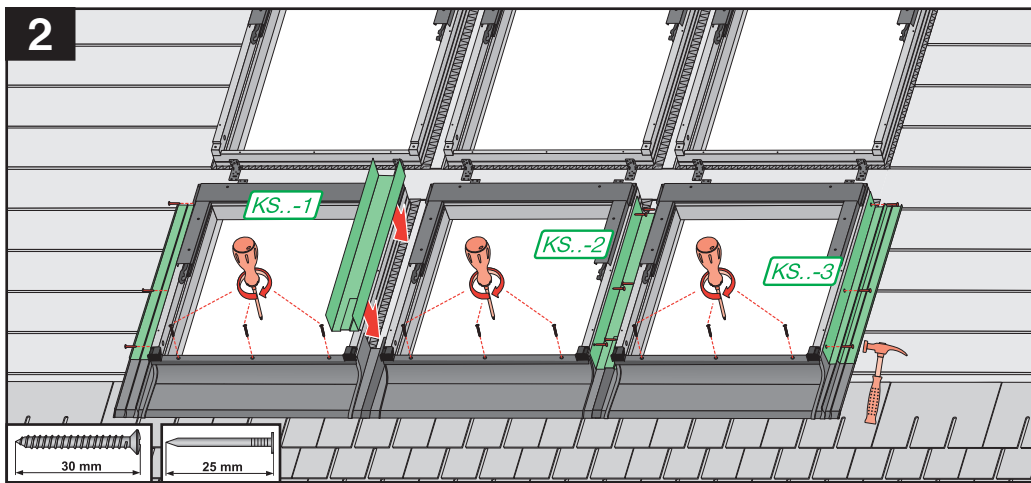

8

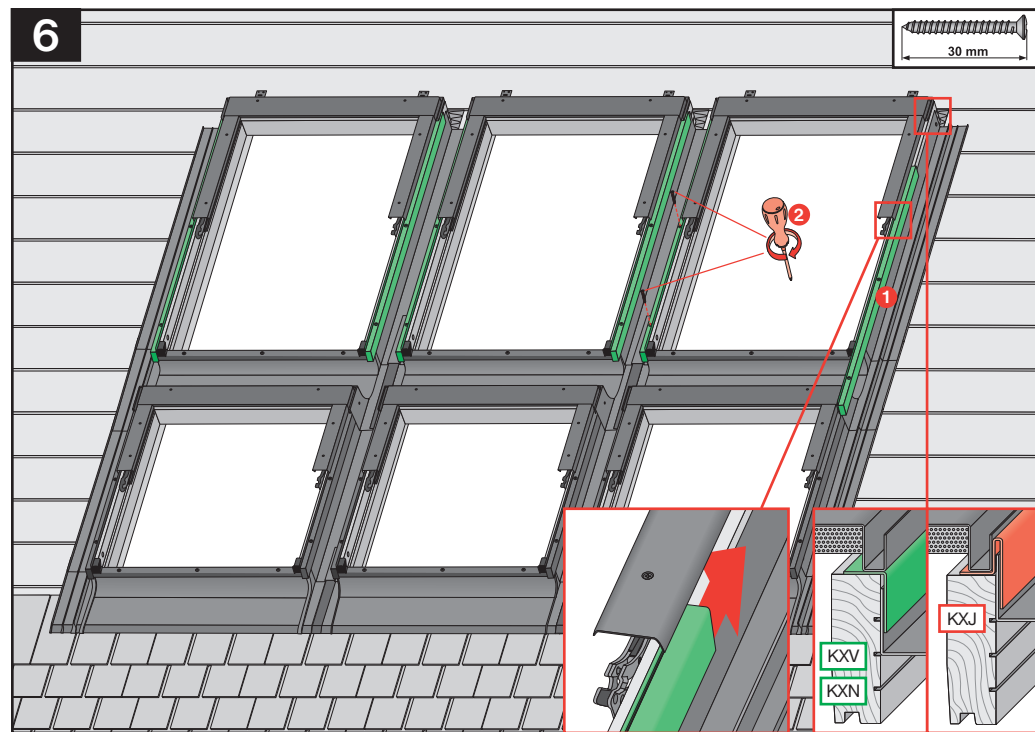
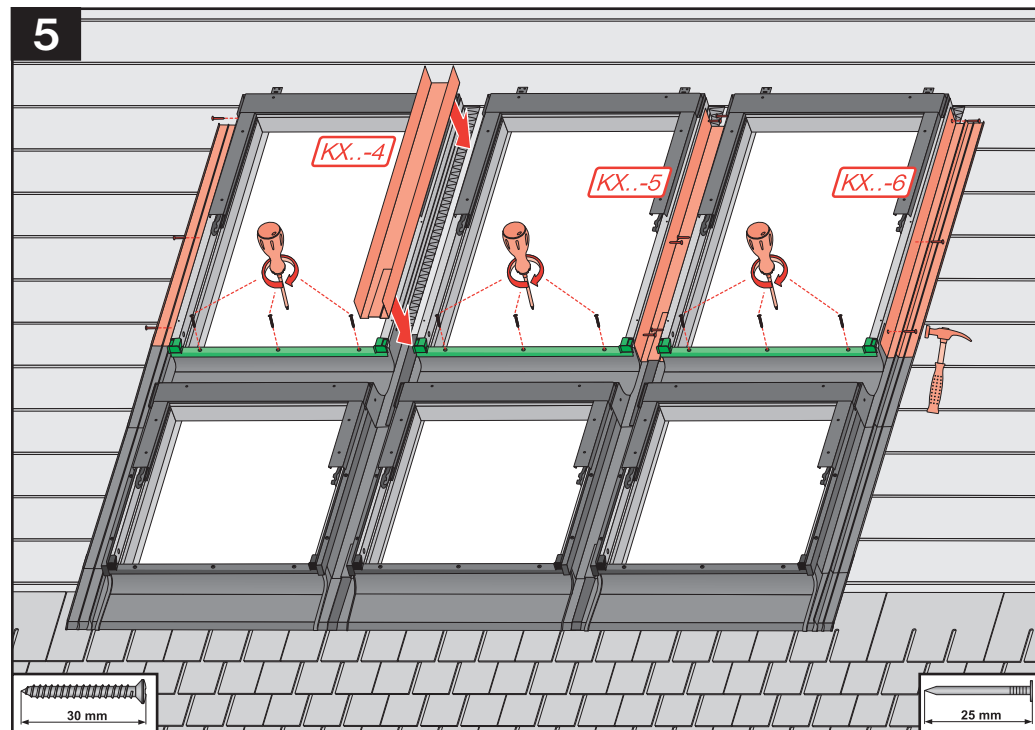

9

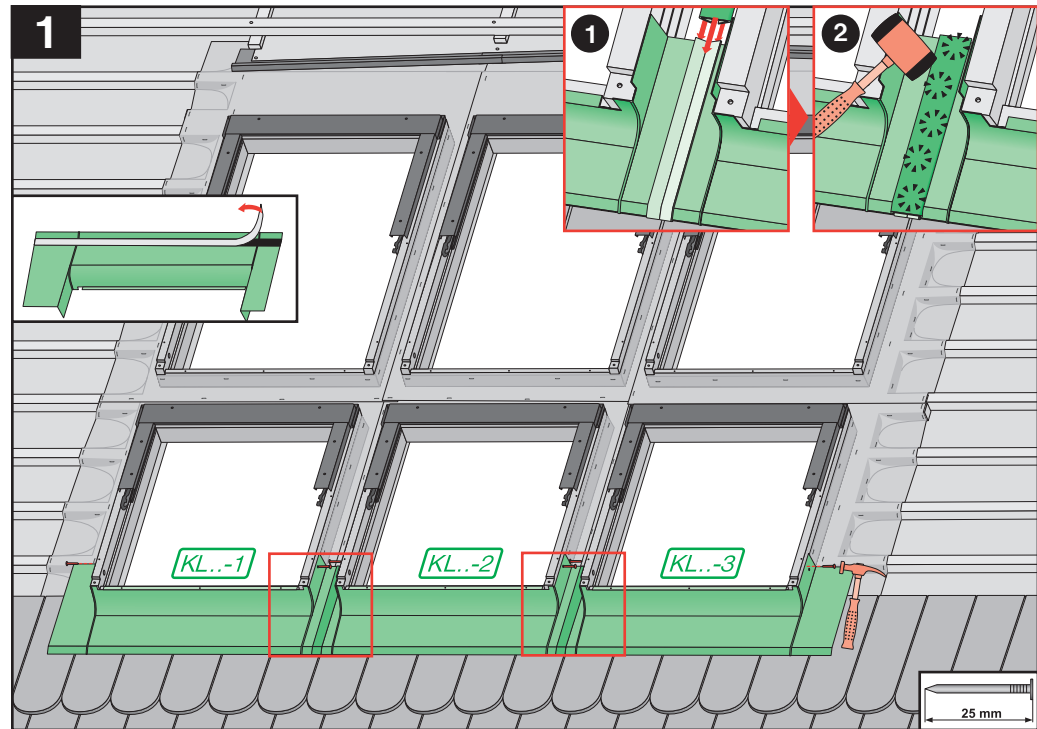
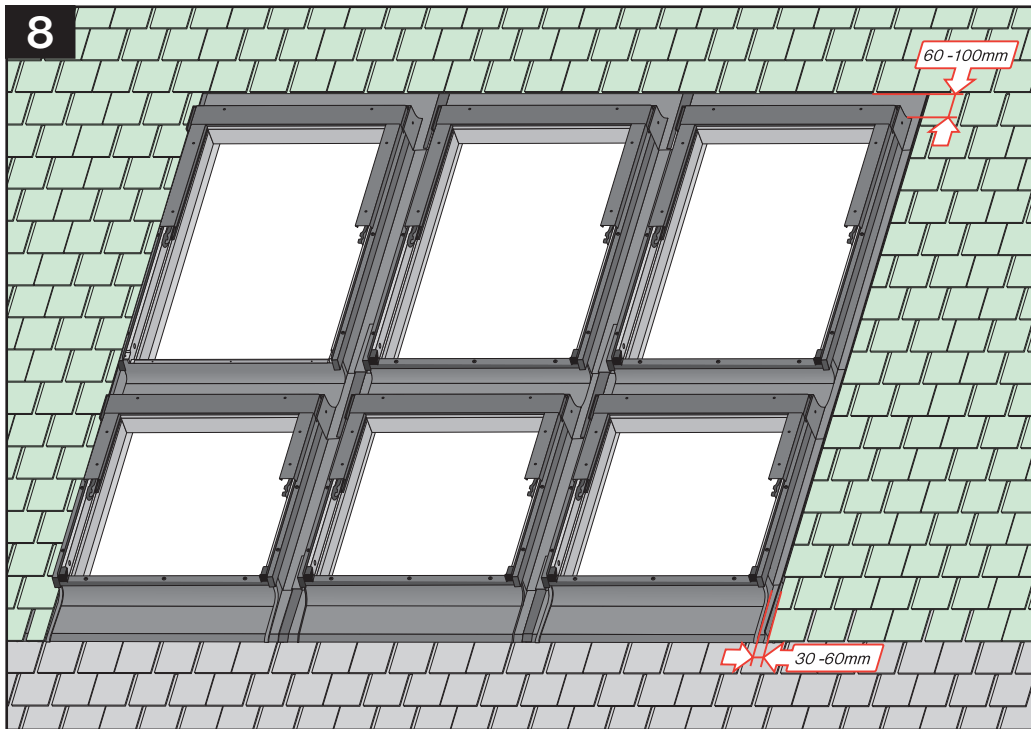
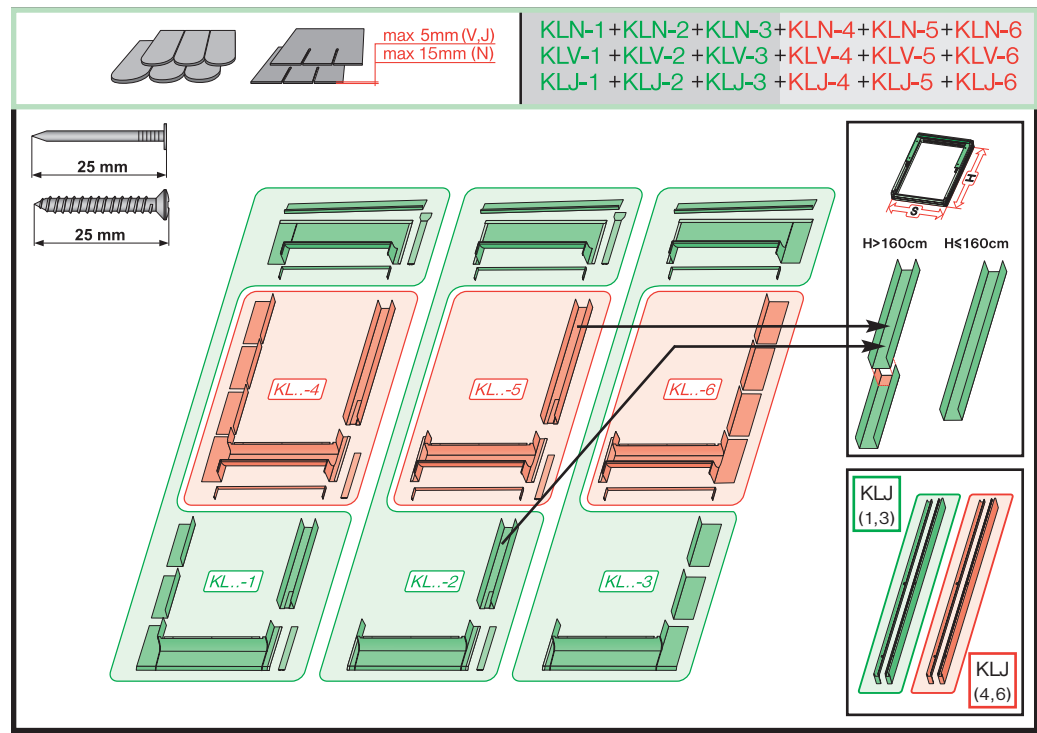
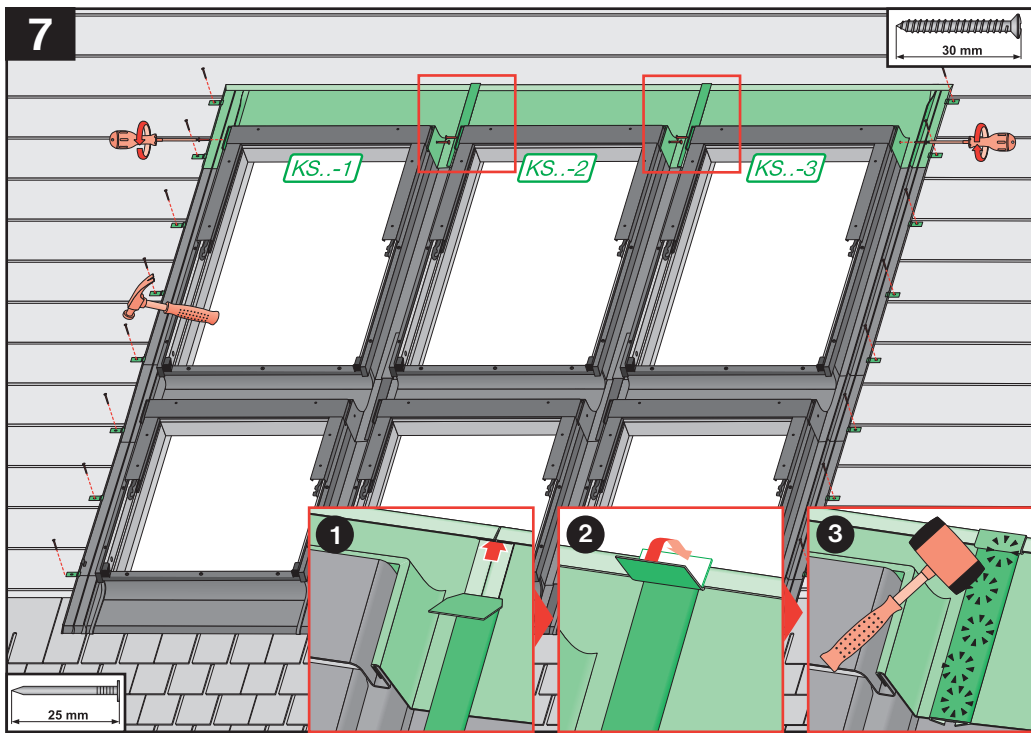

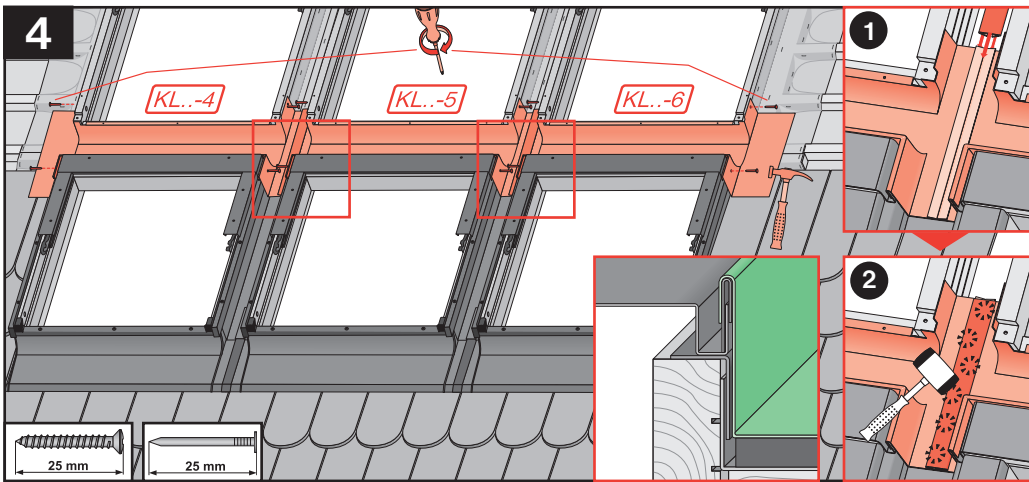
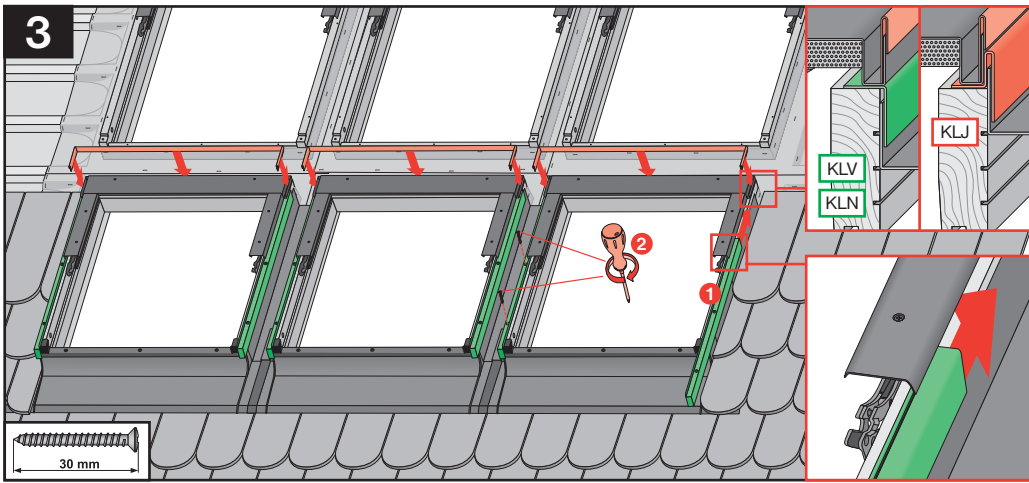
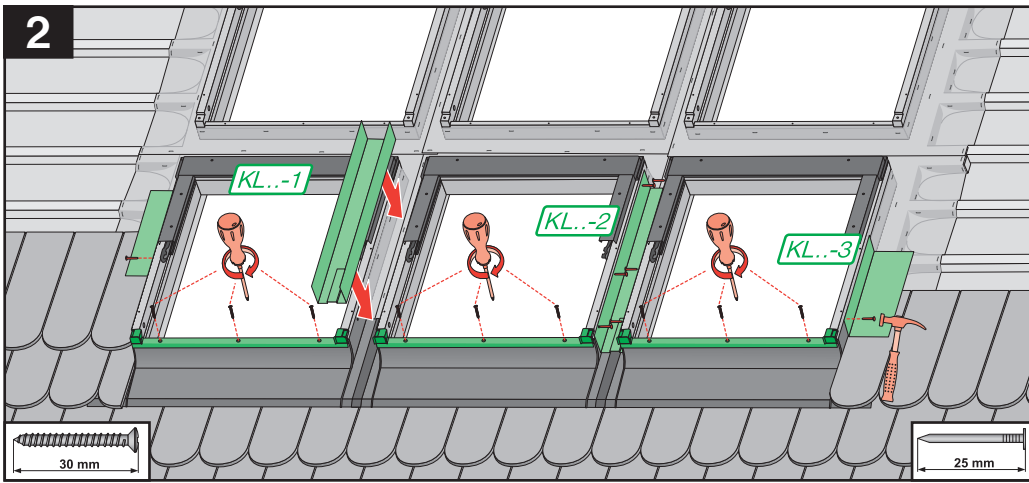

12

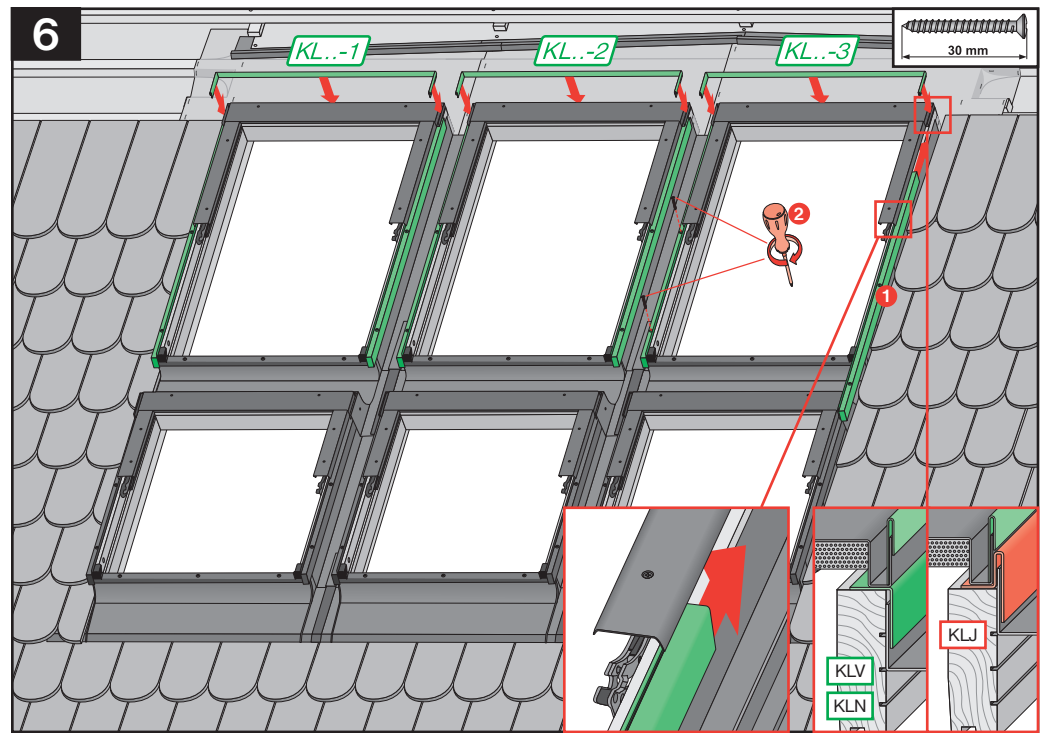
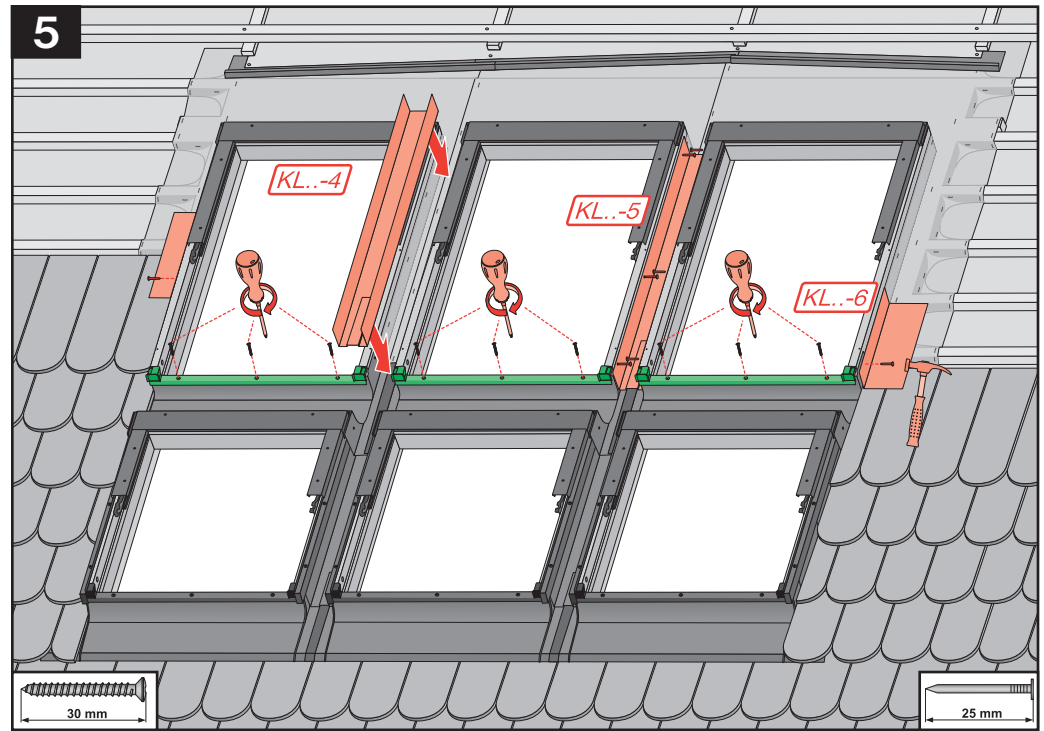

13

