

FTS

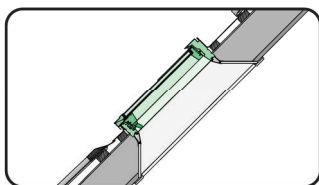

FTS-V

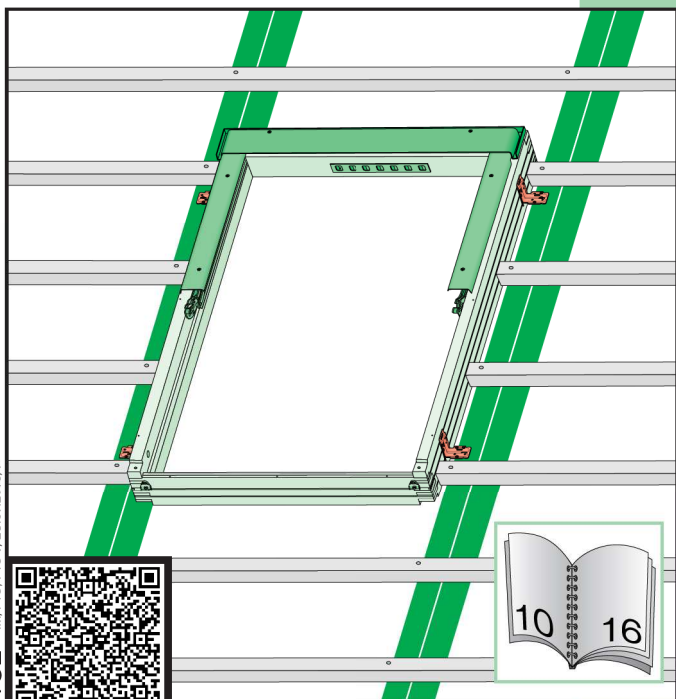

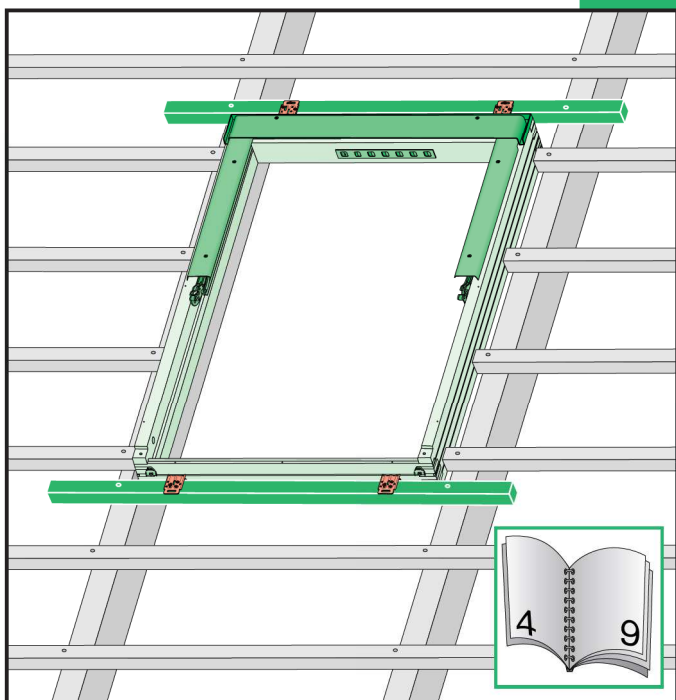
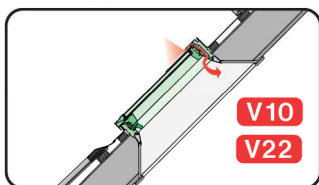
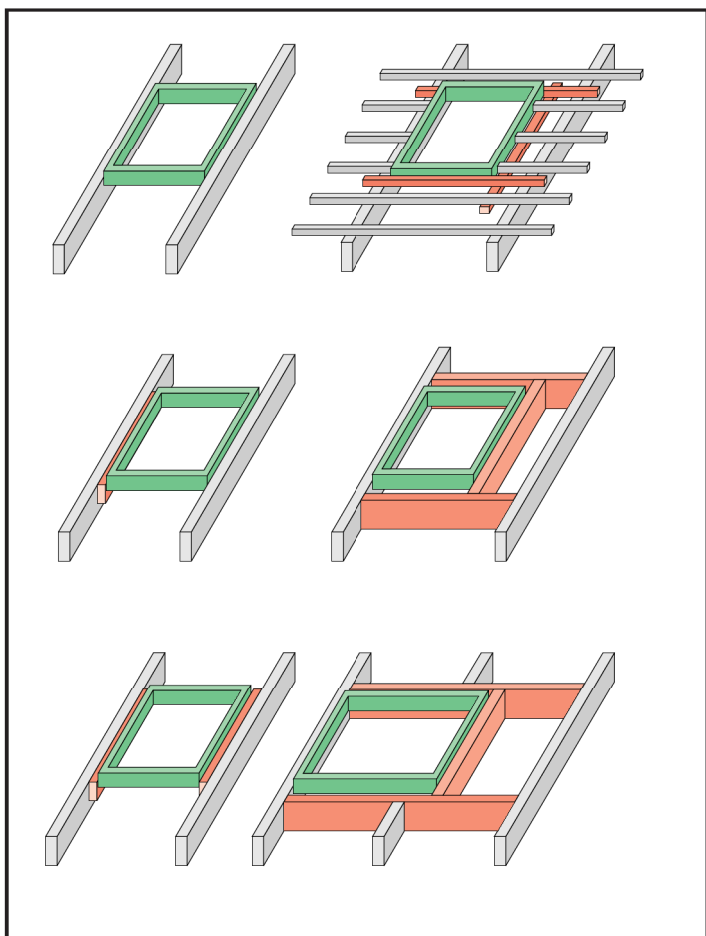
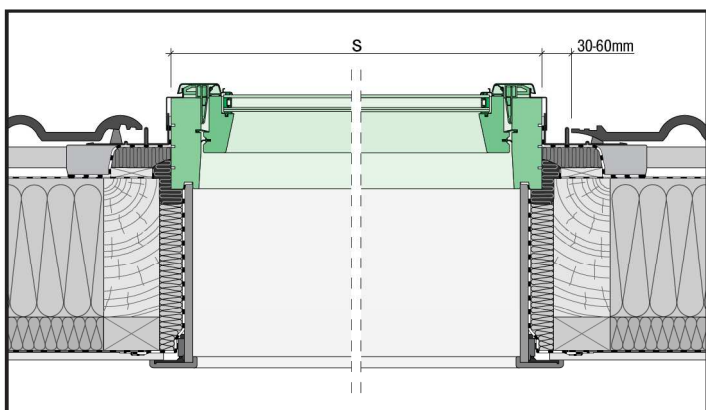
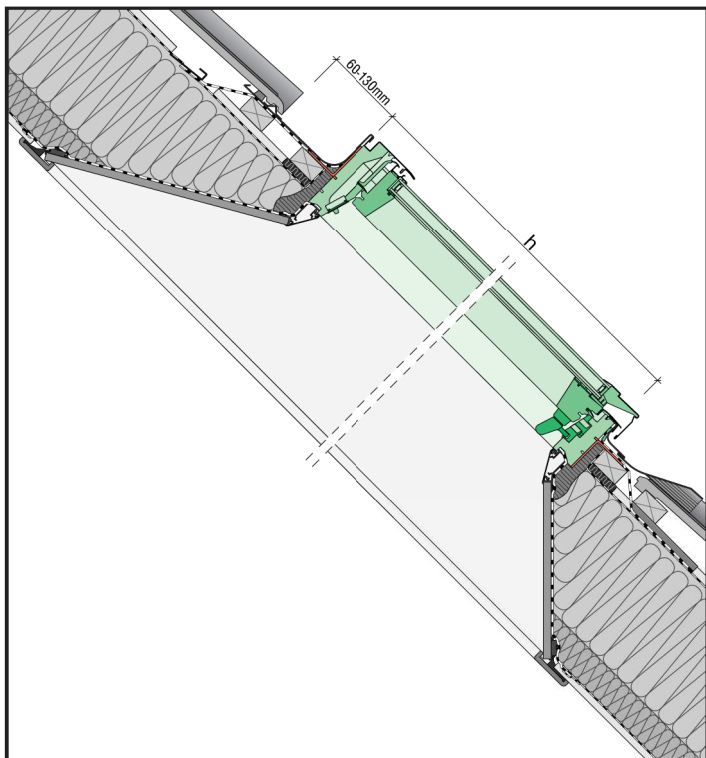



T20

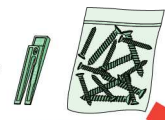
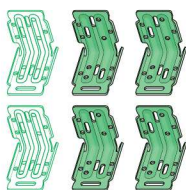
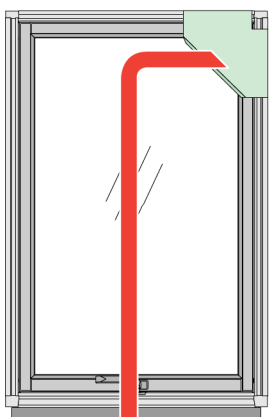

FAKRO



30 mm

80 mm

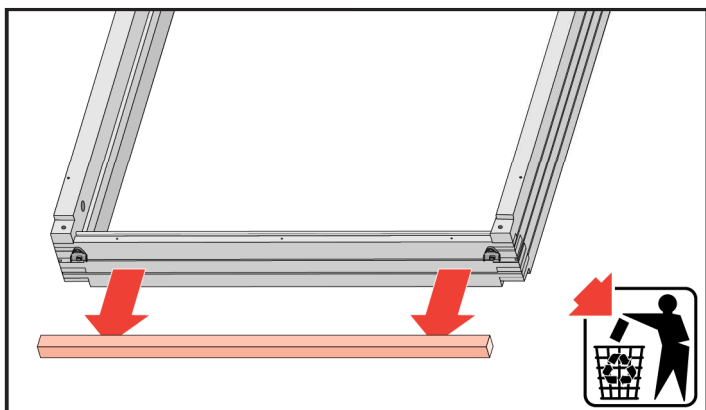
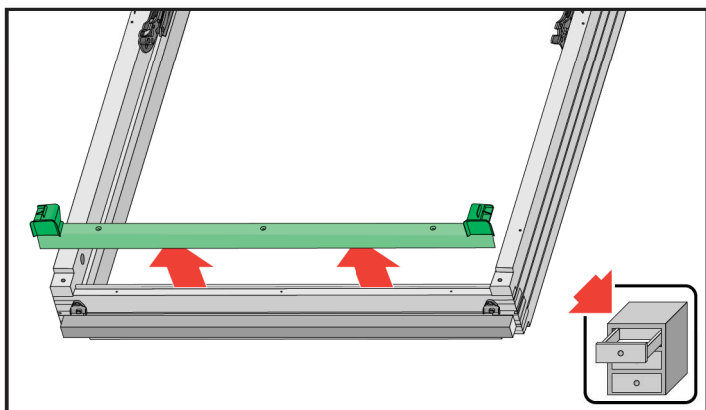
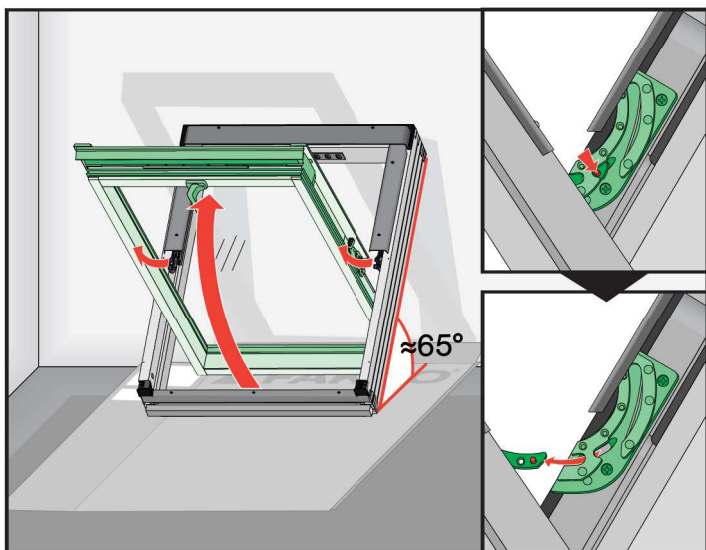

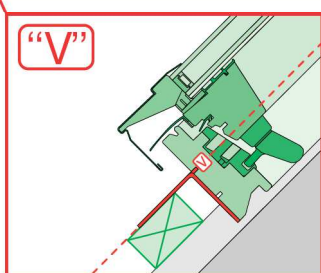
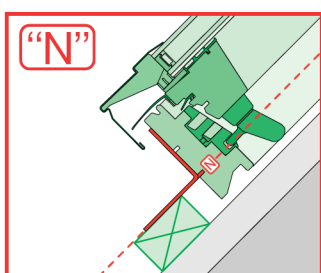
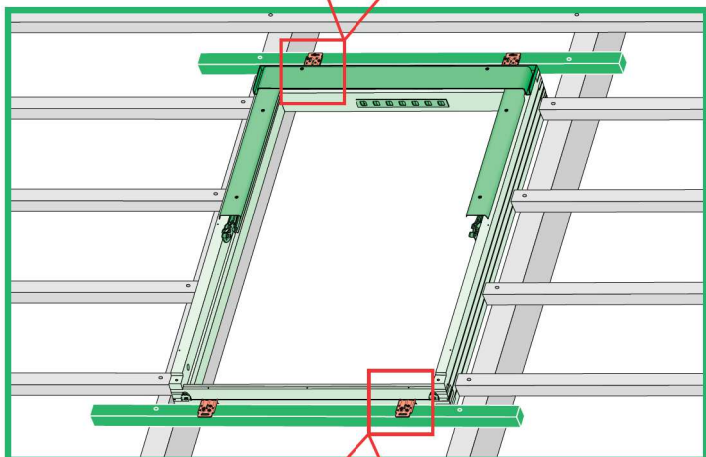
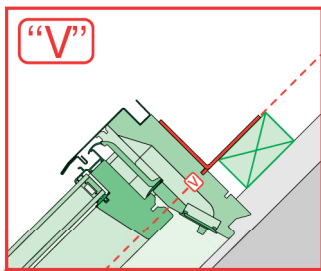
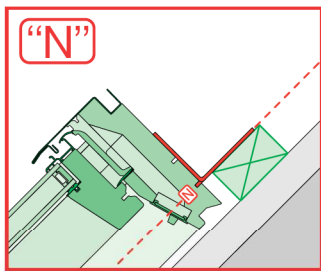

	 max 90mm	EHN		
		EHV		
		-	-	-

	 max 45mm	EZN		
		EZV		
		-	-	-

	 max 15mm (N) max 5mm (V)	ELN		
		ELV		
		-	-	-





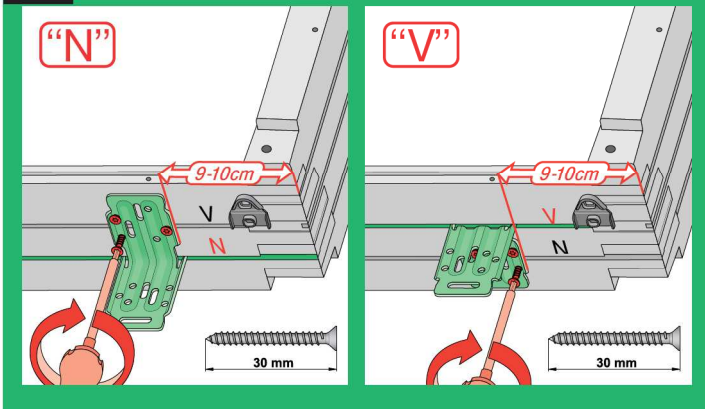



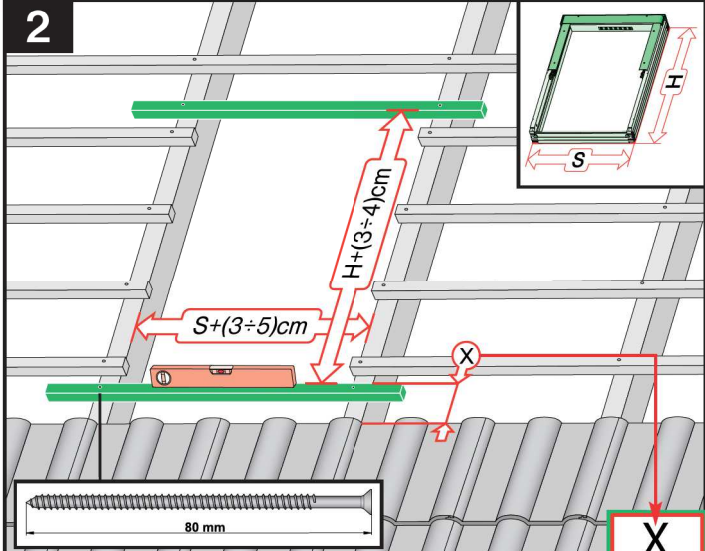

	 max 5mm	ESN		
		ESV		
		-	-	-

1

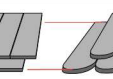
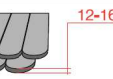
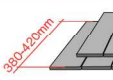
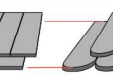
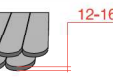

2

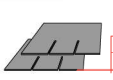
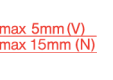
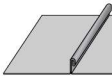

			max 90mm	EHN EHV	7-10cm 7-10cm
			max 45mm	EZN EZV	6-8cm 6-8cm
			12-16mm	EGV	6cm
			12-16mm	EPV	6cm
			max 5mm (V) max 15mm (N)	ELN ELV	0-2cm 0-2cm
				EEN EEV	0-2cm 0-2cm

3

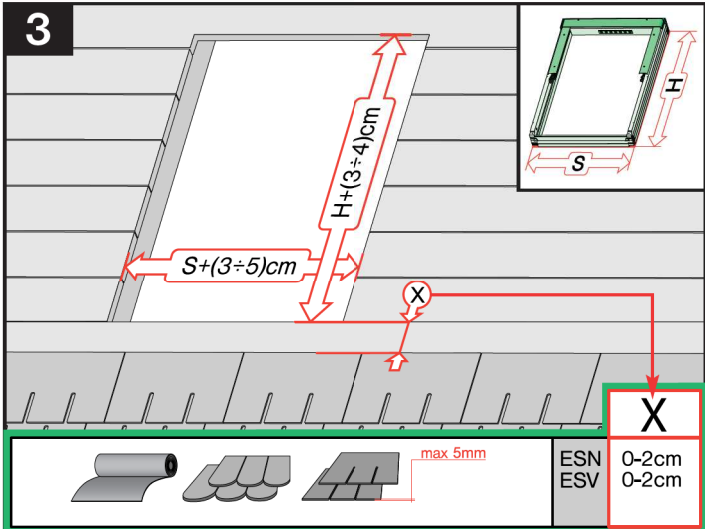

			max 5mm	ESN ESV	0-2cm 0-2cm
---	---	---	---------	------------	----------------

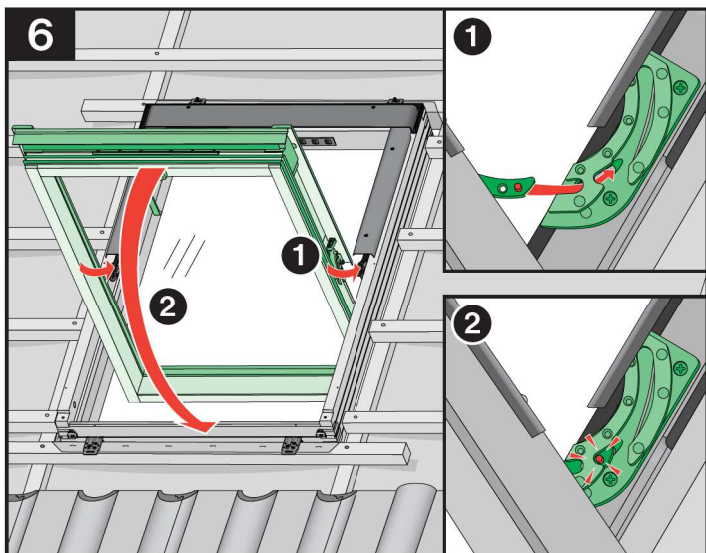
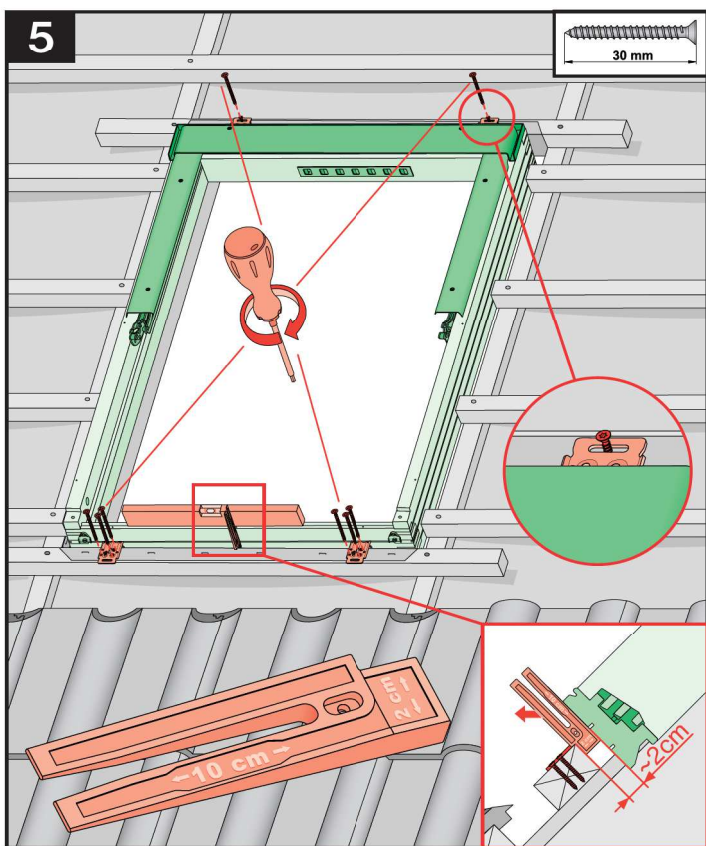
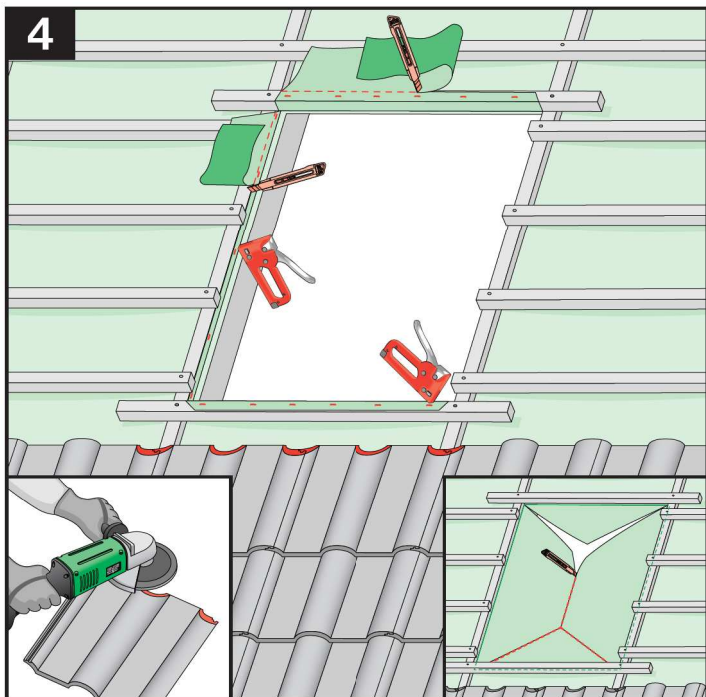

7

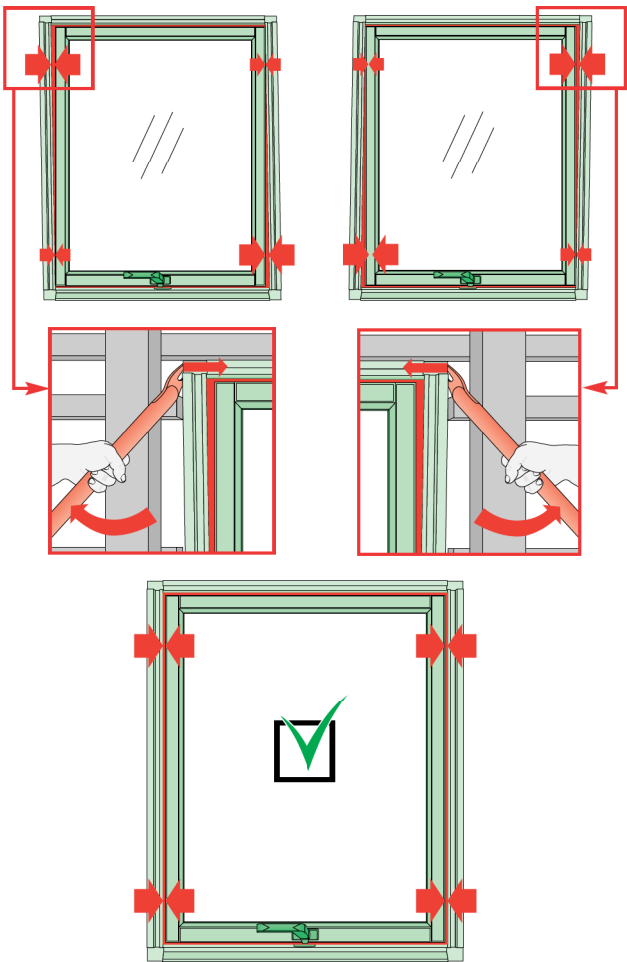

8

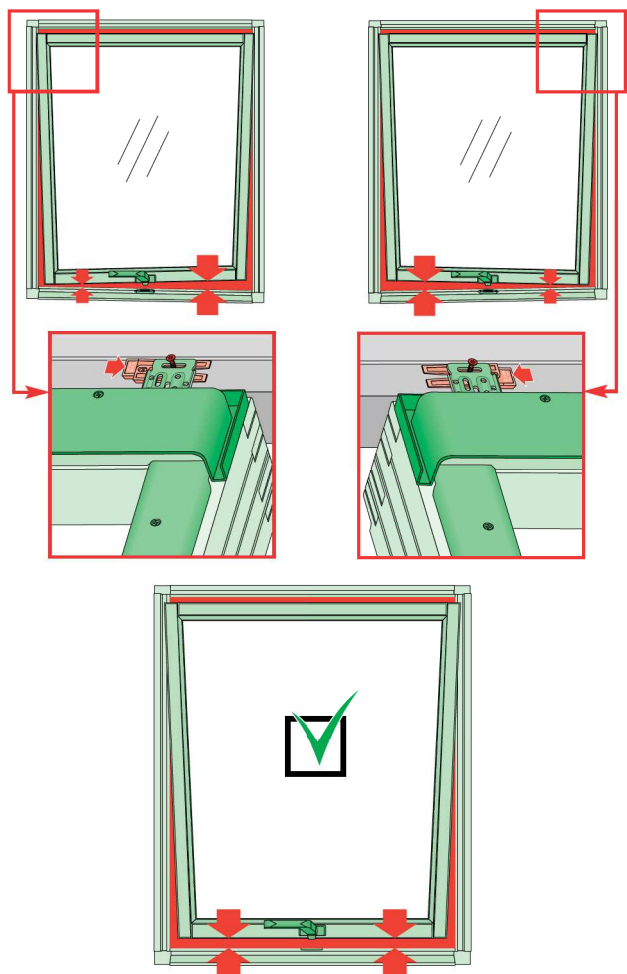

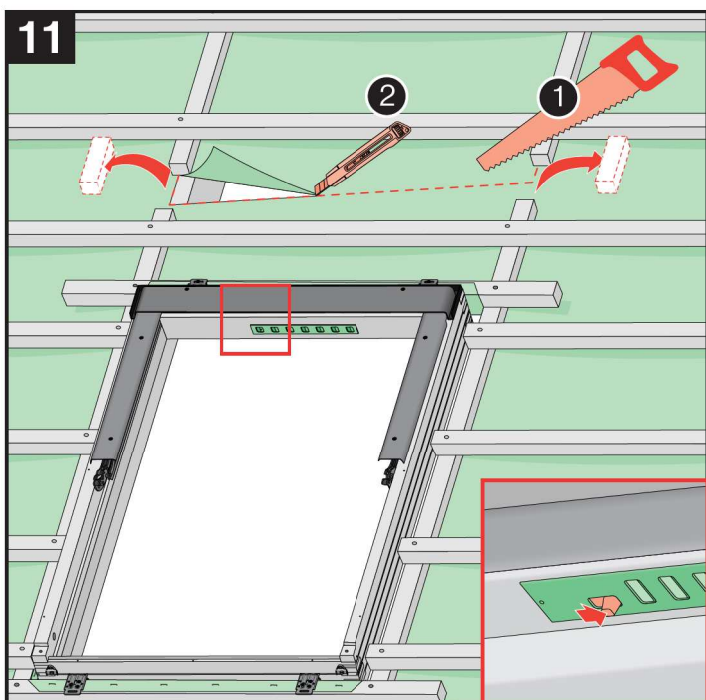
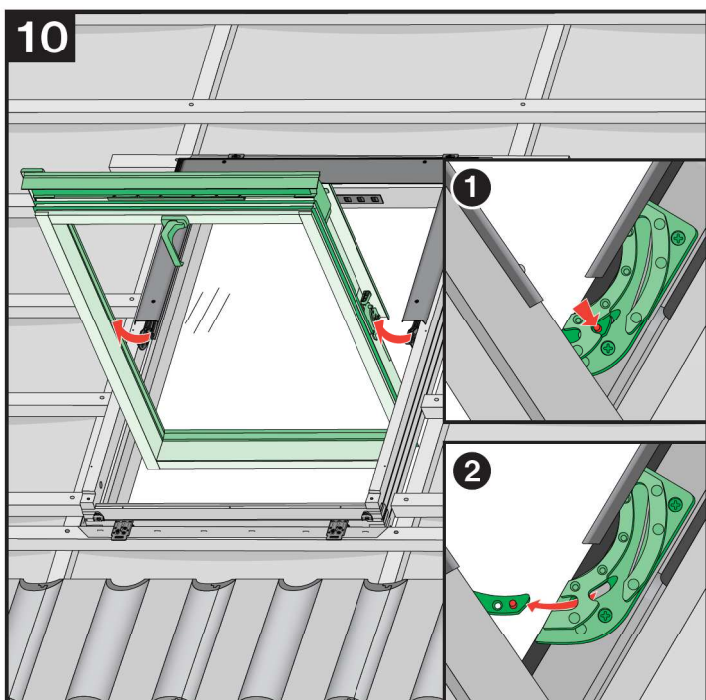
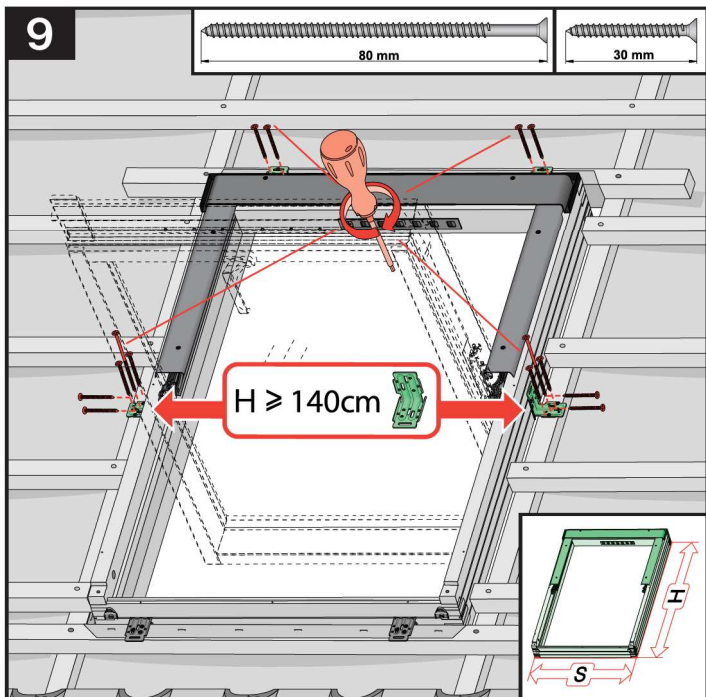



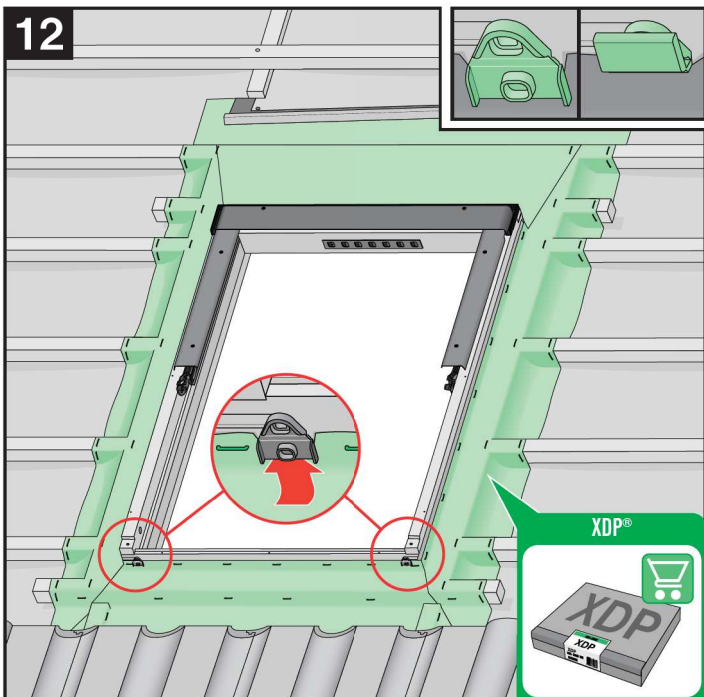

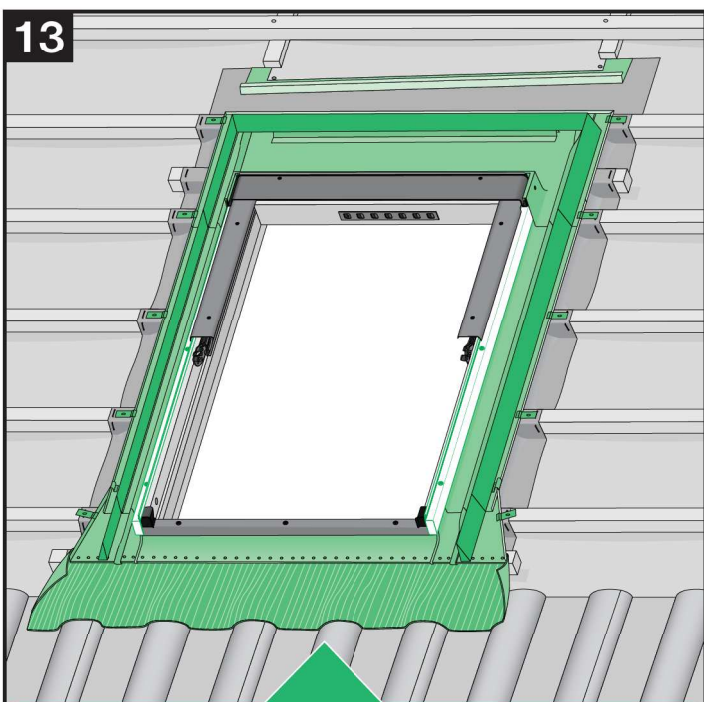

12



13

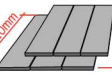

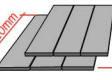
	max 90mm	EHN EHV
	max 45mm	EZN EZV
	max 5mm	ESN ESV
	390-420mm 12-16mm	EGV
	295-220mm max 18mm	EPV
	max 5mm (V) max 15mm (N)	ELN ELV
		EEN EEV



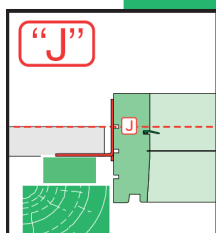
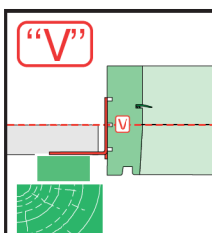
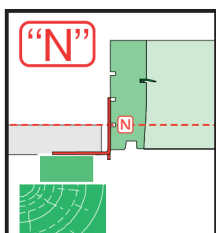
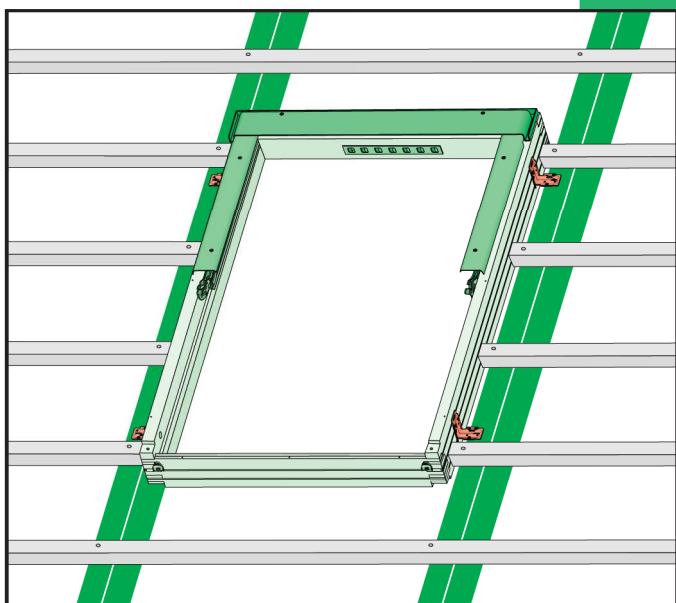

	<p>max 90mm</p>	EHN		
		EHV		
		-		-

	<p>max 45mm</p>	EZN		
		EZV		
		EZJ		

	<p>max 15mm (N) max 5mm (V) max 5mm (J)</p>	ELN		
		ELV		
		ELJ		

	<p>max 5mm</p>	ESN		
		ESV		
		ESJ		

1

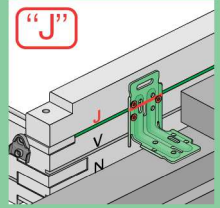
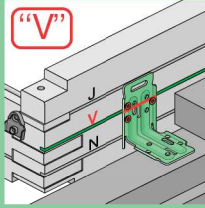
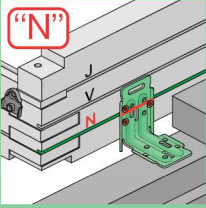
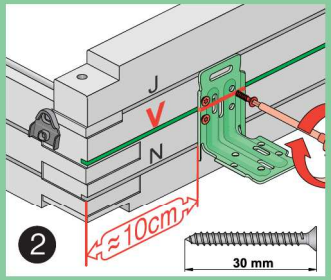
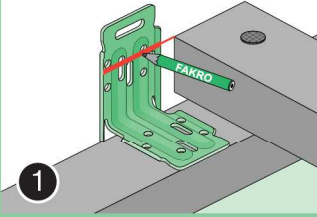

2

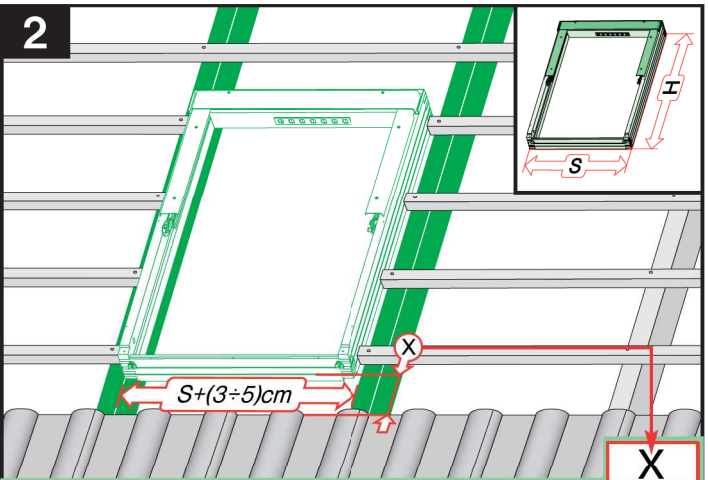

X

<p>max 90mm</p>	EHN EHV	9-12cm 9-12cm
<p>max 45mm</p>	EZN EZV EZJ	8-10cm 8-10cm 20cm
<p>380-420mm 12-16mm</p>	EGV	6cm
<p>250-280mm max 18mm</p>	EPV	8cm
<p>max 5mm (V,J) max 15mm (N)</p>	ELN ELV ELJ	0-4cm 0-4cm 11cm
	EEN EEV EEJ	0-4cm 0-4cm 11cm

3

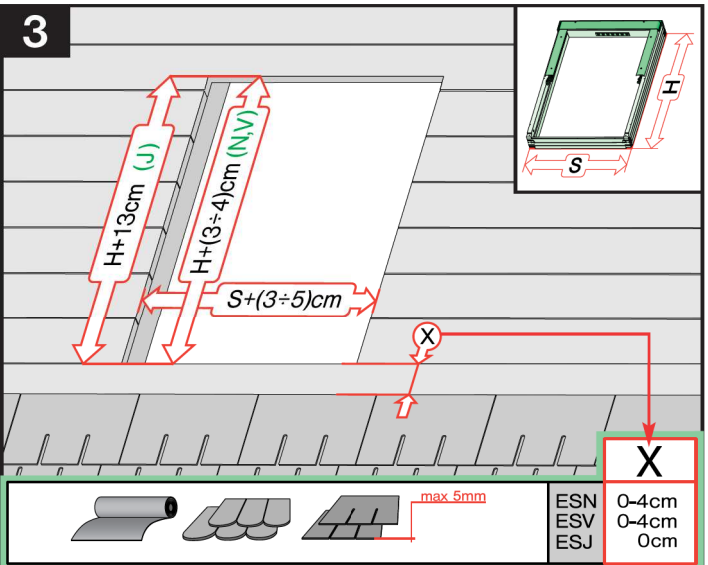

X

<p>max 5mm</p>	ESN ESV ESJ	0-4cm 0-4cm 0cm
----------------	-------------------	-----------------------

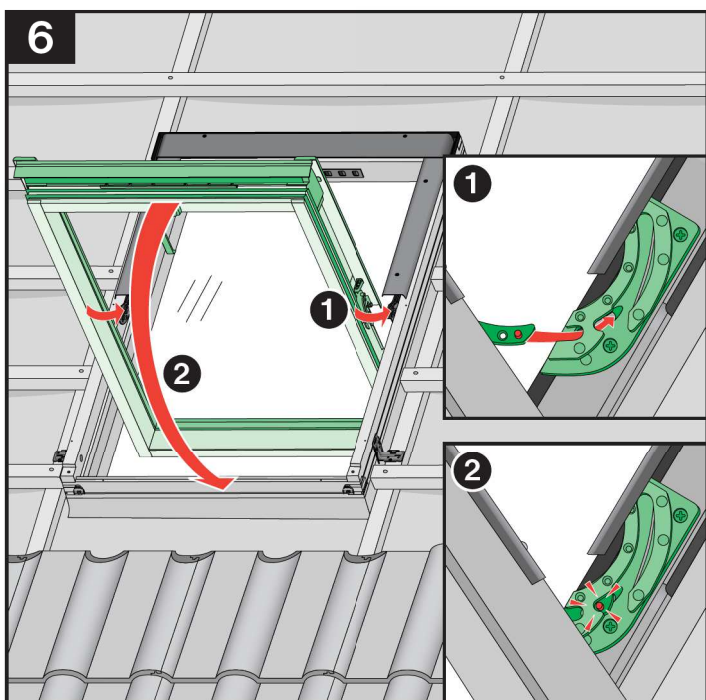
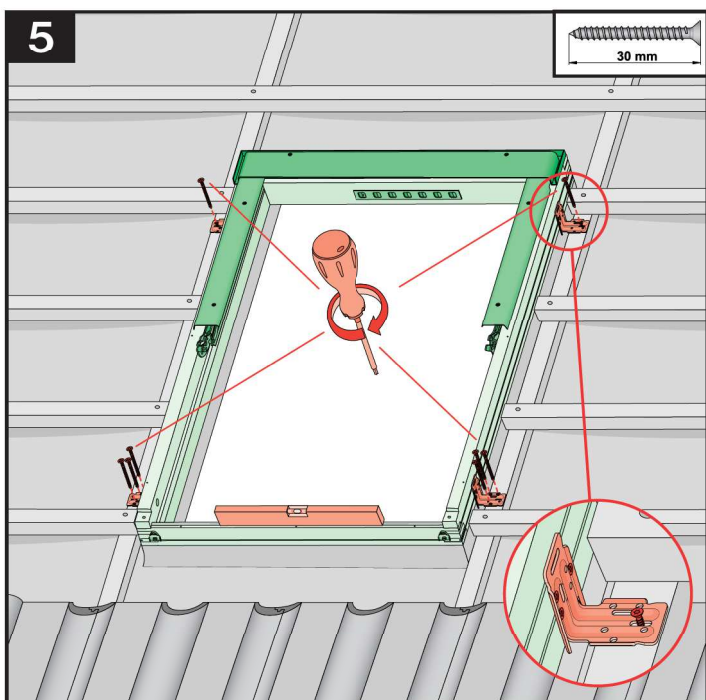
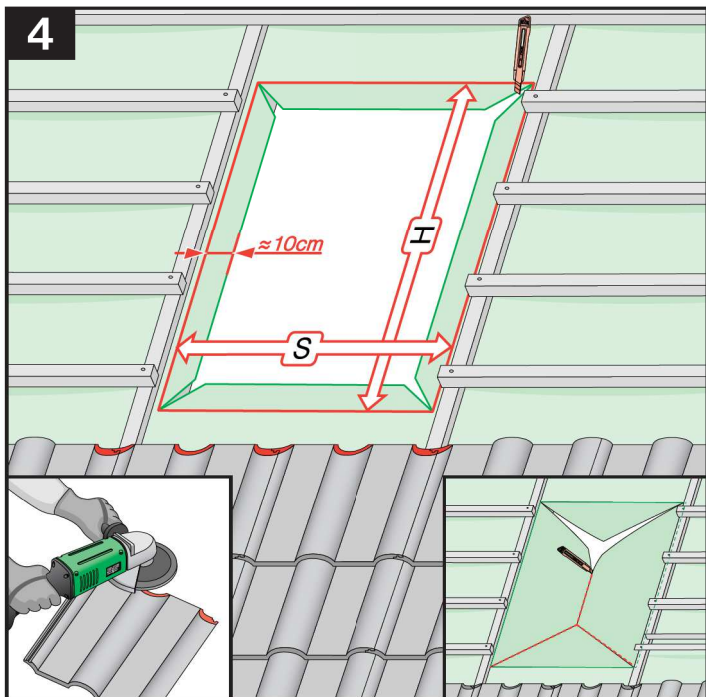

7

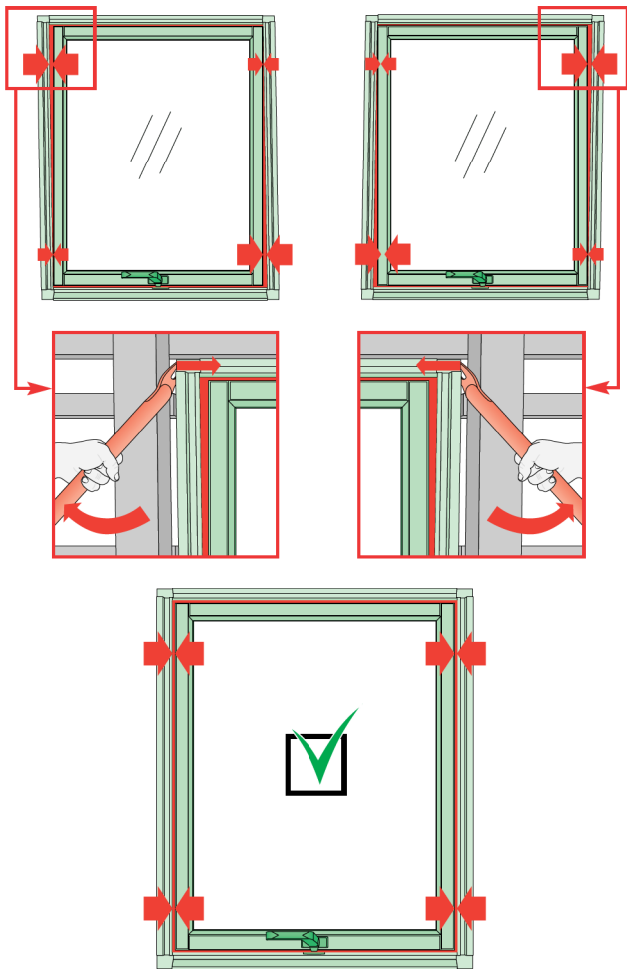

8

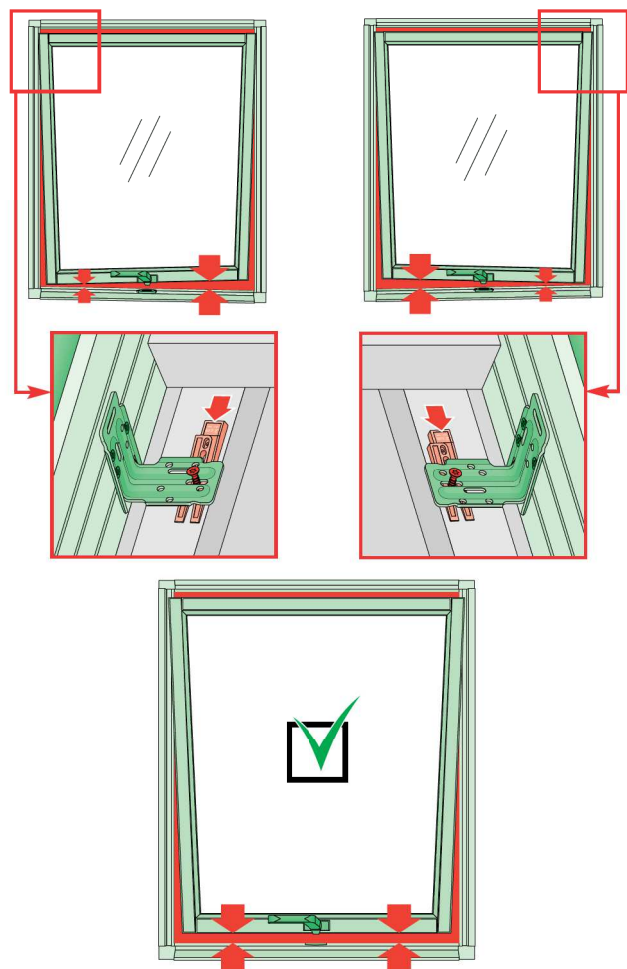

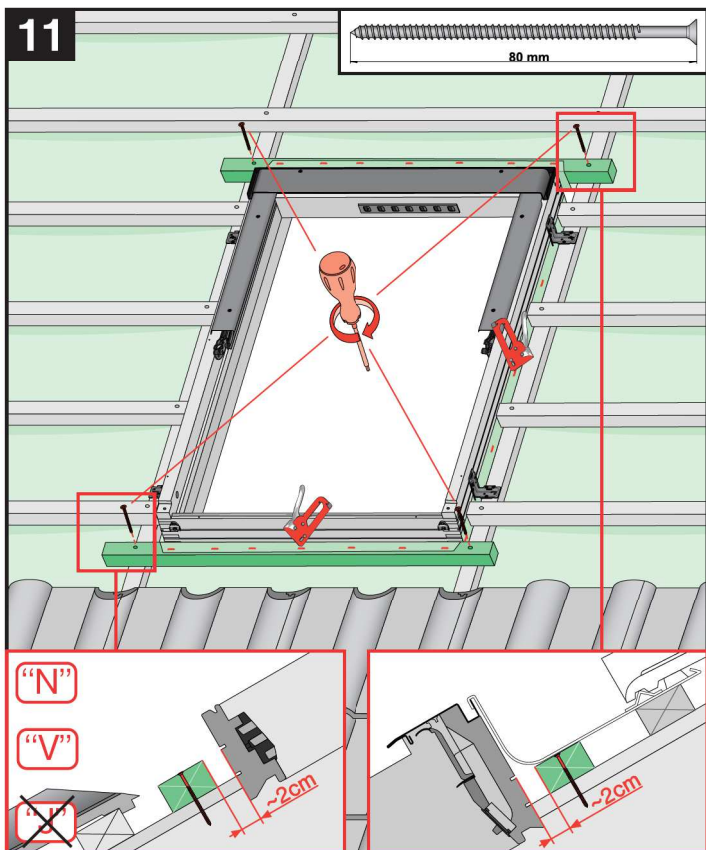
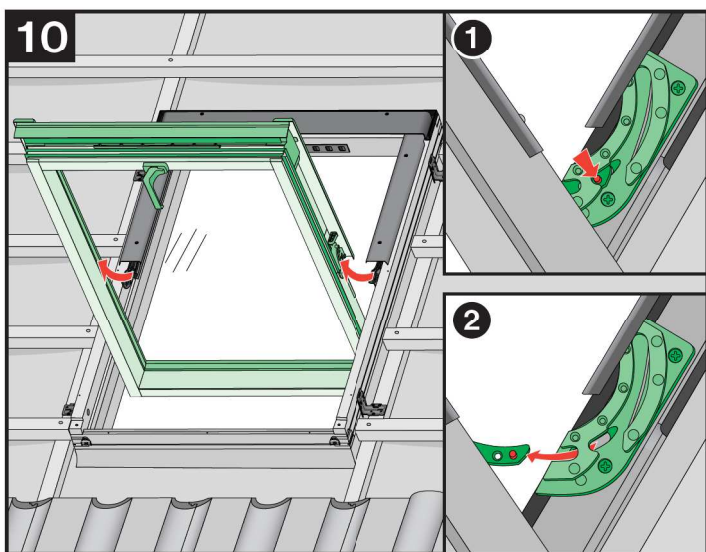
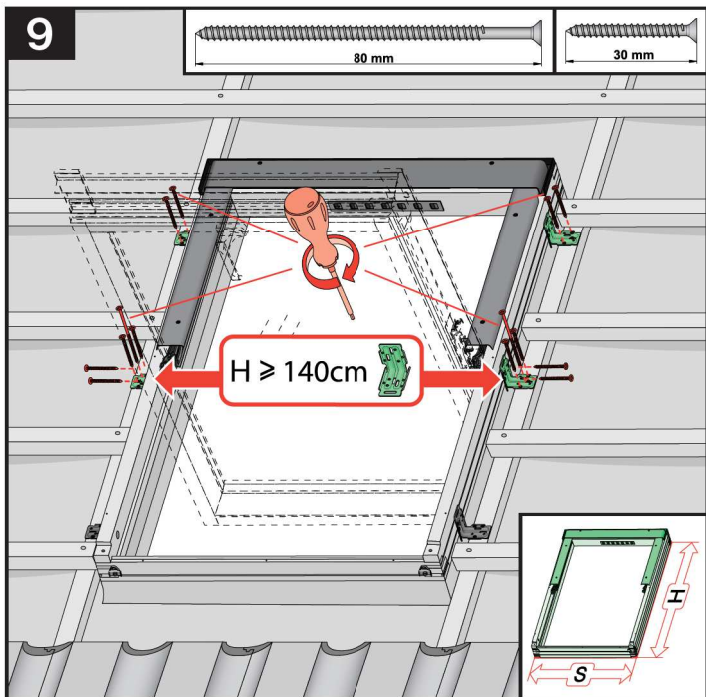

12

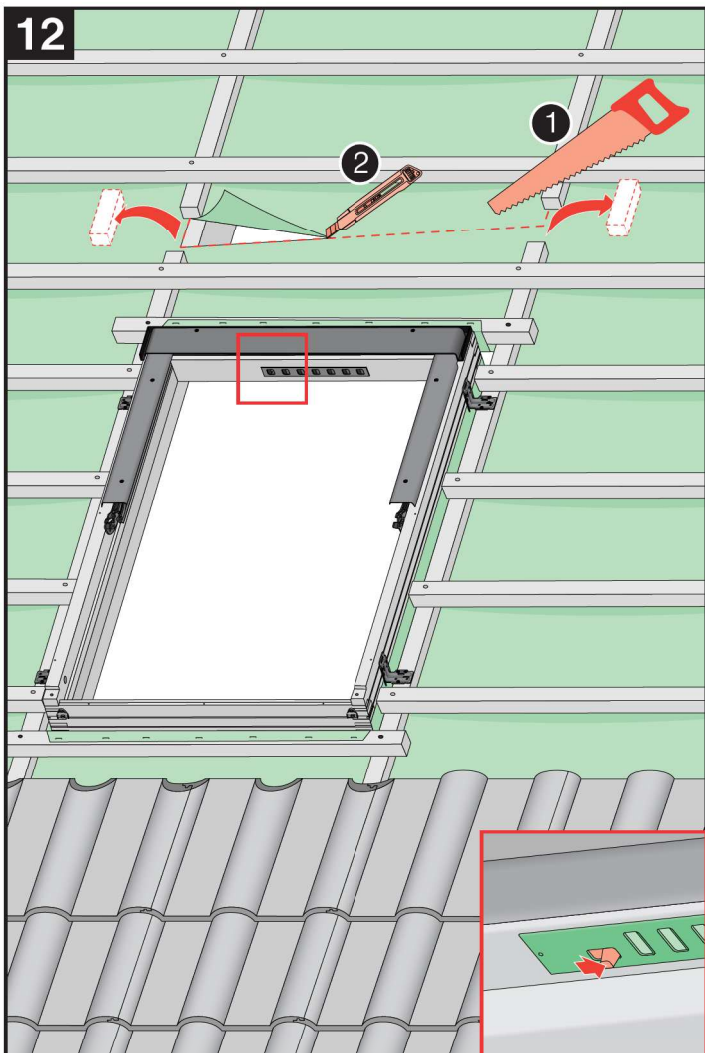

13

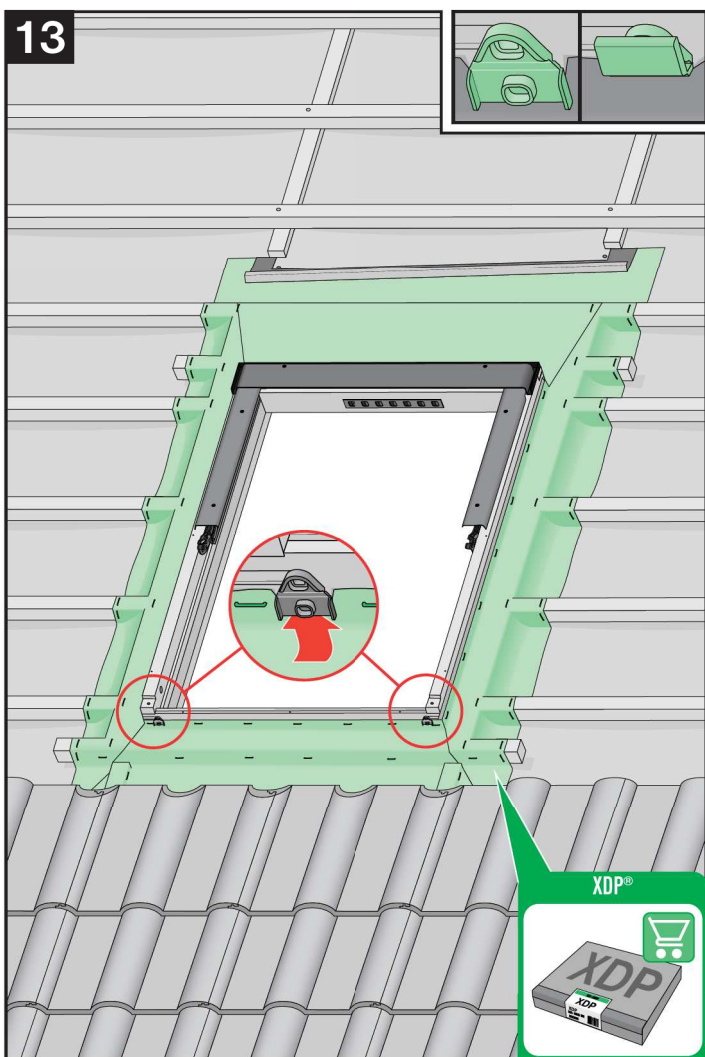

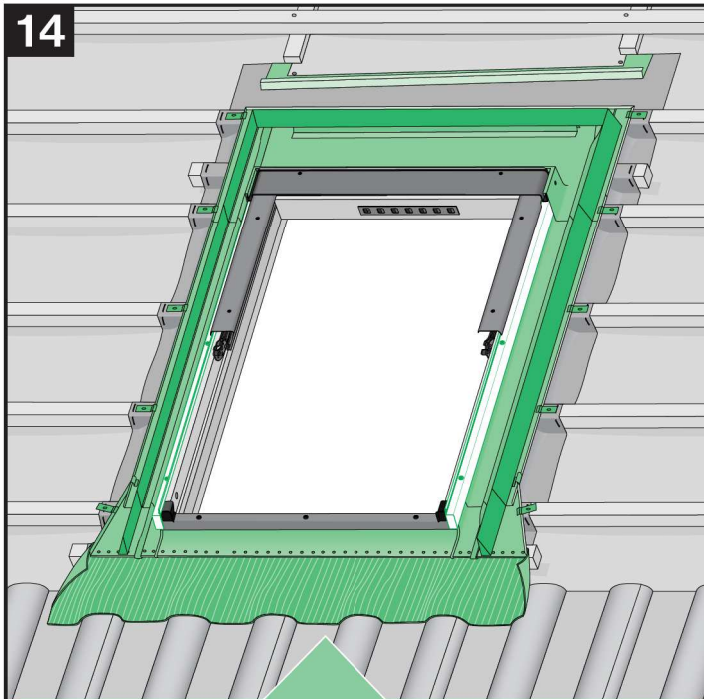

	max 90mm	EHN EHV
	max 45mm	EZN EZV EZJ
	max 5mm	ESN ESV ESJ
	12-16mm	EGV
	max 18mm	EPV
	max 5mm (V) max 15mm (N)	ELN ELV ELJ
		EEN EEV EEJ

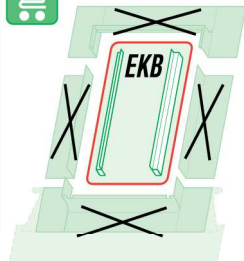
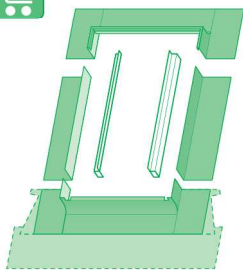

CZ Výrobce a Prodejce nenesú žádnou odpovědnost za nedodržení příslušných předpisů zákona, stavebních předpisů a bezpečnostních požadavků přes užívatele výrobku, architektu, montéra nebo majitele objektu.

DE Hersteller und Verkäufer übernehmen keine Haftung für Nichtbeachtung entsprechender Rechts- und Bauvorschriften sowie Sicherheitsanforderungen seitens Produktbenutzers, Architekten, Monteurs oder Gebäudebesitzers.

ES El fabricante y el vendedor no tienen ninguna responsabilidad por el incumplimiento de la ley vigente, normas de construcción y exigencias de seguridad por parte del usuario del producto, arquitecto, instalador o el propietario del edificio.

FR Le fabricant et le revendeur ne prend aucune responsabilité de ne pas respecter les lois applicables, les règlements sur les bâtiments et les exigences de sécurité par l'utilisateur du produit, l'architecte, l'installateur ou le propriétaire du bâtiment.

GB Manufacturer and Seller shall bear no liability for failure to comply with the applicable laws, building codes and safety requirements by the user of the product, architect, fitter or owner of the building.

HU A Gyártó és a Forgalmazó nem vállal semmiféle felelősséget a vonatkozó törvényi, építési és biztonsági előírások termékfelhasználó, építész, beépítőmester vagy épülettulajdonos általi nem tartásáért.

IT Il Produttore e il Rivenditore non potranno essere ritenuti responsabili per il mancato rispetto, da parte dell'utente del prodotto, del progettista, dell'installatore o del proprietario dell'edificio, delle leggi vigenti, nonché dei regolamenti edilizi e di quelli relativi alla sicurezza.

NL De fabrikant en verkoper zijn niet aansprakelijk voor gevolgen bij het niet opvolgen van toepasselijke wetten, bouwverordeningen en veiligheidsvoorschriften door de gebruiker van het product, de architect, de installateur of de eigenaar van het gebouw.

PL Producent i Sprzedawca nie ponosi żadnej odpowiedzialności za nieprzestrzeganie stosownych przepisów prawa, przepisów budowlanych i wymogów bezpieczeństwa przez użytkownika produktu, architekta, montażystę lub właściciela budynku.

PT O fabricante e o vendedor não tem nenhuma responsabilidade pelo o não cumprimento da lei, códigos de construção e as exigências de segurança por parte do usuário do produto, arquiteto, instalador ou proprietário do edifício.

RO Nici producătorul, nici distribuitorul nu își vor asuma niciun fel de răspundere pentru nerespectarea legilor în vigoare, a legilor din domeniul construcțiilor sau a măsurilor de siguranță impuse utilizatorilor produsului, arhitecților, montajorilor sau proprietarilor clădirii.

RU В случае несоблюдения архитектором, монтажником или владельцем здания строительных правил и норм безопасности ответственность с производителя и продавца снимается.

SK Výrobca a predajca nenesú žiadnu zodpovednosť za nedodržanie príslušných ustanovení zákona, stavebných predpisov a bezpečnostných požiadaviek užívateľom výrobku, architektom, montérom alebo majiteľom objektu.